

integrity

INTEGRATED SOLUTIONS

Access Control | Intruder Detection | Security Management



ir inner range

www.innerrange.com

Intelligent Security Solutions

Inner Range have been designing and manufacturing integrated Security and Access Control systems for over 30 years. Today there are more than 50,000 installed Inner Range systems delivering state-of-the-art solutions to corporations, government departments and institutions all around the globe.



All these organisations rely on their Inner Range systems, great and small, to secure and manage their critical assets.

The Inner Range research centre in Melbourne, Australia is home to a large engineering and product development team which is supported by an even larger complement of dedicated test engineers, trainers and IT technical support specialists.

Inner Range products are sold around the world by a network of authorised distributors who are committed to standards of service that reflect Inner Range's commitment to excellence.





Software

6-23

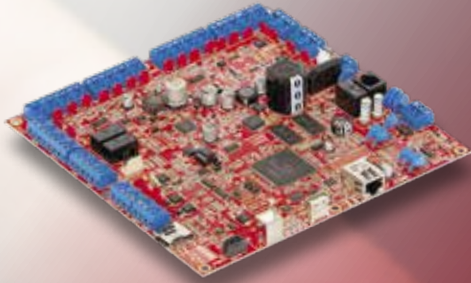

Hardware

24-79



Multipath-IP

80-87



Power Supplies

89-95



Enclosures

96-103



Product Index

104-109



The Integriti System

Integriti is an IP-connected integrated Access Control and Intruder Detection system which is modular and scalable by design. This means that Integriti is well suited for security applications in small commercial buildings through to large multi-campus institutions or enterprises that span the globe.

















In addition to Integriti's powerful Access Control & Intruder features, a vast array of powerful interfaces to third party systems is also possible. The Integriti application becomes the control centre and hub of all interconnected sub-systems, thereby allowing the user to manage their entire security operation through the one intuitive desktop application.

The Integriti system can also be managed using web based interfaces and even mobile devices such as tablets or smart-phones.

The Integriti Technology Platform is the result of more than 30 years of continuous industry participation and product development by the people at Inner Range.

Integriti has set new industry standards and can offer real solutions in today's exciting yet demanding technology environment.

Features at a glance ...

-  Modern design, intuitive and simple to use.
-  Build cardholder profiles by assigning multiple permissions with simple "Allow" or "Deny" functions.
-  Complete alarm management with powerful automated actions.
-  Rich graphics with vector scalable interactive floor plans and maps.
-  Forensic audit trail recording every programming change with the ability to "roll-back" any change.
-  Email, SMS text messaging and pager communications.
-  Easy-to-use reporting such as Time on Site, Muster and detailed commissioning reports.
-  Integration with Active Directory, HR, payroll and other database applications.
-  PhotoID card design and printing.
-  Client/Server architecture, fully compatible with modern computing platforms using Microsoft SQL databases.
-  Web interface for card-holder programming and basic monitoring and control of the system.
-  Integration with a wide range of third party systems.
-  Plug-and-play UniBus for easy in-cabinet expansion.
-  Upgrade firmware for Controllers and LAN modules over-the-wire.
-  Backwardly compatible with Concept LAN modules.
-  Increased Cyber Security with 2 Factor Authentication for operators

Apple and Android Apps

The Integrati Mobile Apps pack a powerful punch of accessibility and control for your Integrati Security and Access Control system. With the tap of a finger, these exciting Apps allow remote operation of your Integrati system from anywhere in the world!



<http://www.innerrange.com/pd/Integrati-System/Mobile-Applications/Integrati-Mobile>



Simplicity of Use

Large or small, everyday use of the Integrity system is simple. Unlock doors, turn on or off security areas all by simply presenting a card at a reader or by using the colour graphic keypad. Manage the entire system via intuitive Windows® based software.

Scalability

Integrity is perfect for small sites through to large multi-campus institutions. Only pay for what you want when it's needed; Integrity's flexible modular design means it grows with demand as required. And because it's an IP-based networked solution, utilise new or existing I.T. infrastructure for boundless connectivity.

Cyber Security

Inner Range's devices utilise cryptographic implementations including AES encryption that are certified by NIST through their Cryptographic Algorithm Verification Program to the FIPS 140-2 standard. The cloud services, servers, web clients, and mobile apps are secured with HTTPS / TLS and the MS SQL database can support TLS and TDE which uses AES 256-bit encryption

Affordable on any Scale







Integrity delivers a state-of-the-art solution with tangible cost savings through its integrated Security, Access Control and Building Automation functionality.

Contemporary Design

Inner Range SIFER Card Reader & PrismaX Keypad



Use the Integrity system to:

-  Monitor and control the movement of all personnel and vehicles in the facility. Protect critical assets and manage the safety of staff and visitors.
-  Easily assign access permissions mandating who can go where and when, including visitor access.
-  Manage the reporting of security alarms and audit their responses.
-  Ensure compliance with business policies and government regulations.
-  Respond to emergency situations, lockdowns and alerts.
-  Manage WHS liability by leveraging competency-based access control permissions.
-  Remotely monitor and control the Integrity system with iOS and Android Apps.
-  Manage the entire security operation from a single user interface. With Integrity acting as the complete Integrated Security Management System (ISMS), integrate a variety of security sub-systems, such as CCTV, Biometrics, Mobile Duress, Lighting, Air-Conditioning, Intercom, Fire and much more.

Software

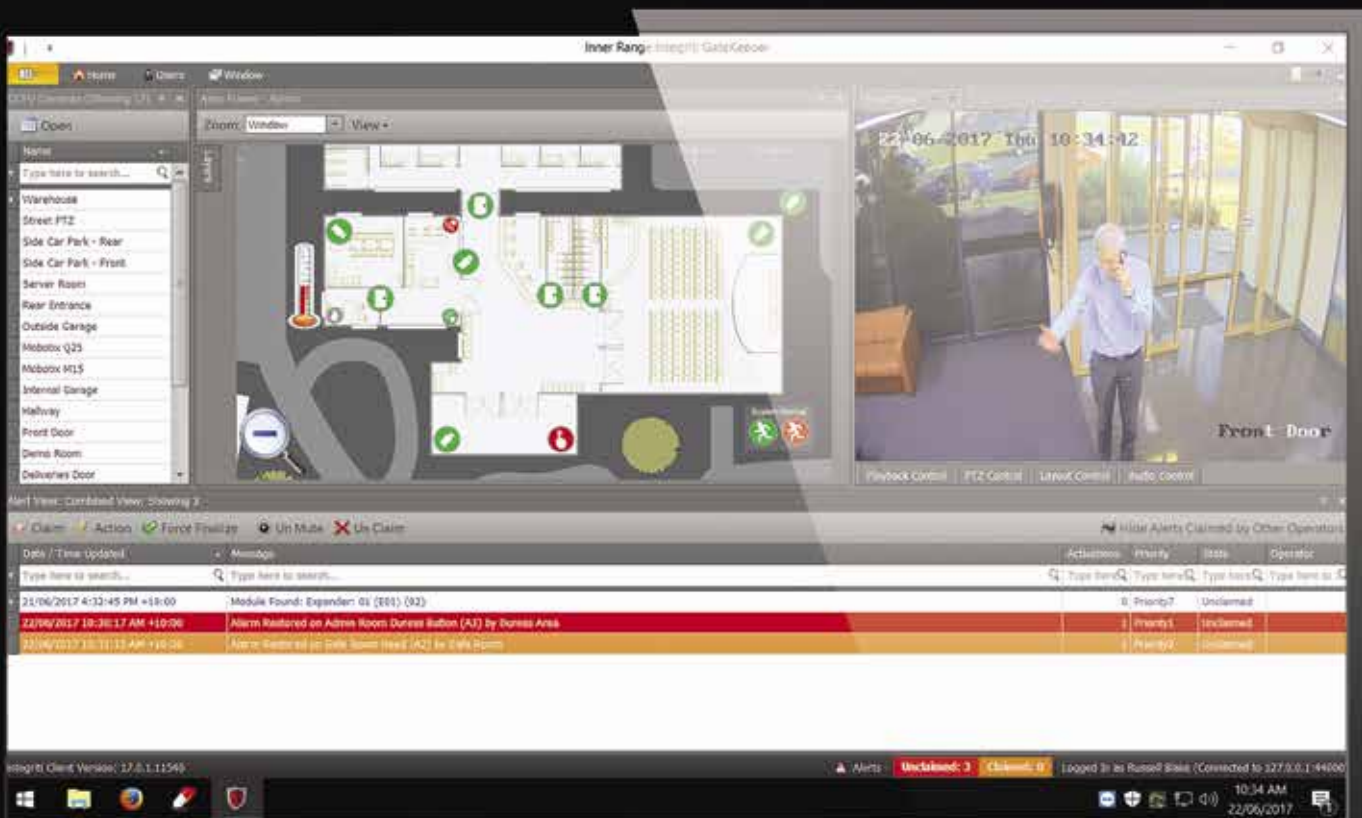

The Integriti System Management Suite is a true cutting-edge solution. Featuring the very latest technologies, Integriti has been designed with an innovative and user-friendly design as its core focus.

Integriti Professional, Business & Corporate Software Editions offer everything your customer will need for complete system management. Each Edition includes GateKeeper and System Designer:

- Integriti **GateKeeper** for everyday card-holder programming, monitoring and control of the system.
- Integriti **System Designer** for full system programming and configuration.

Optional Web Client Interface and Smartphone Apps are also available.

Integriti Professional, Business & Corporate Editions

These Software Editions may be deployed on any number of local or remote sites. Individual sites retain their functional autonomy, while system users and permissions are managed globally across the entire organisation. These Editions also support a wide range of integration options to existing HR systems and a variety of third-party products.













Integriti Express

An Express version of Integriti is available for smaller single-controller sites. This is a great solution where the advanced features of the Professional version are not required.

Integriti Commissioning Software

Commissioning Software (CS) is also available for security technicians who are installing and commissioning Integriti systems. CS is provided to trained Inner Range security technicians.

Software features at a glance ...

-  Web Client Interface.
-  Programming and commissioning time significantly reduced via automated processes.
-  Build cardholder profiles by assigning multiple permissions with simple "Allow" or "Deny" functions.
-  Modern design, intuitive and simple to use.
-  Complete alarm management with powerful automated actions.
-  Rich graphics with interactive floor plans and scalable vector based maps.
-  Forensic audit trail recording every programming change with the ability to "roll-back" any change.
-  Email, text message and pager communications.
-  Easy-to-use reporting such as Time on Site, Muster and detailed commissioning reports.
-  Integration with Active Directory, HR, payroll and other database applications.
-  Upgrade firmware for all Integriti hardware modules.
-  Client/Server architecture, fully compatible with modern computing platforms using Microsoft SQL databases.
-  Integration with other systems: CCTV, Intercoms, Building Automation, Personnel Tracking, Mobile Duress and many more. Use Integriti as an overarching Security Management System for complete control of security and facility services.

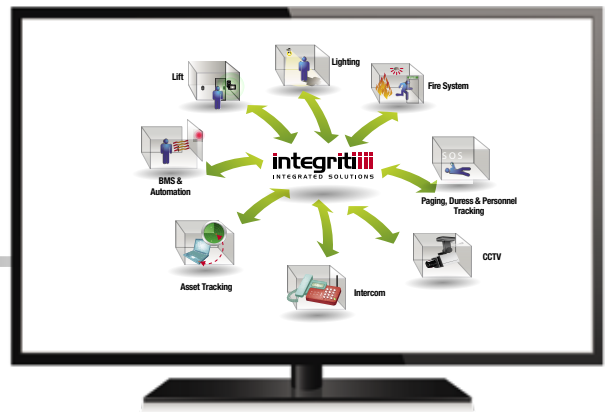

Integrati Security Management Software is available in four individual editions. Starting with the entry level Express edition and expanding through to the highly featured Corporate edition, Integrati Software offers the perfect security management solution for any organisation.



Professional Edition - 996901

The Professional Edition provides powerful tools for systems that require multiple Controllers and multiple sites. With no limit to the quantity of Controllers or Integrati Mobile App connections Professional is designed to centrally manage large security and access control systems that may extend over many geographical locations. Professional also includes power features such as Communicator for sending email, SMS and pager messages, Dynamic User Importing tool for importing card holder data from third-party systems and Photo ID card designer.

Express to Professional Upgrade – 996905UPG



Business Edition - 996901B

The Business Edition is designed for organizations that use Integrati Software as part of their every day routine and site security management. Inclusive of all the features available in Express and Professional, the Business Edition extends the scope of the system to include powerful functions such as Advanced Reports, the Integrati Web Interface, Active Directory integration and CCTV integration with License Plate Recognition (LPR) functionality.

(Business provides up to 32 CCTV cameras by default and additional cameras can be added in lots of 8)

Professional to Business Upgrade – 996901UPGB



Corporate Edition - 996901C

The Corporate Edition takes everything from Professional and Business and adds the ability to have up to 30 operators utilising the system at the same time as well as the ability to connect an unlimited number of CCTV cameras.

Advanced security applications for organisations requiring a high level of security and advanced on-site guarding features are also included such as Advanced Alerts, Operator Challenge, Guard Tour and SNMP Health monitoring.

Business to Corporate Upgrade – 996901UPGC



Express Edition - 996905

The Express edition is the entry-level software solution. With features such as User/Cardholder Management, Basic reporting and Forensic Audit trail, Express is designed for small sites with a single Integrati Controller and up to 16 doors of access control.

**Professional Edition - 996901**

Integriti Professional includes a powerful suite of tools and features that are standard as part of the base package.

Features include:

**User/Cardholder Management**

The incredibly flexible user permissions provide an easy-to-use, building block method of assigning access and security rights to cardholders. Cardholder profiles are easily created by assigning multiple permissions with simple "Allow" and "Deny" functions.

**Data Importation**

Import cardholder data from third-party systems.

**Basic Reporting**

Single-click reporting to review the areas cardholders have accessed, what areas cardholders have access to, search event and alarm history, programming history and much more. Easily export reports in a variety of common file formats.

**System Health Monitoring**

Monitor the health of both the Integriti hardware and software. Proactive notifications can alert security operators and security contractors if maintenance is required.

**Schematic Maps**

Control Integriti through easily creatable, graphic rich, interactive scalable vector based floor plans and maps.

Operators are able to view doors, check their status or unlock them within the map. If CCTV cameras are integrated the operator can easily find cameras close to the door and view a live stream or playback footage from them without leaving the map

**SkyTunnel Connectivity**

SkyTunnel is an industry-first cloud-based service that provides hassle-free connectivity of Integriti hardware, software and mobile apps.

**Security and Alarm Management**

Complete alarm management with powerful automated actions.

**Intuitive Design**

The Integriti System Management Suite is a true cutting-edge solution. Integriti boasts a contemporary and intuitive design that is simple to use and easy to learn.

**Operator Permissions**

Manage the operators that use Integriti software. Easily customise and define their access permission levels with fine control.

**System Designer and GateKeeper Applications**

System Designer is used for all aspects of system programming and configuration. GateKeeper is a dedicated application to simplify day to day monitoring and control of the Integriti system.



Communicator - Email, SMS & Pager Communications

The Communicator feature allows messages to be sent from the Integriti server, either manually or automatically, using the various communication paths available.

E-mails: Specify an SMTP mail server

SMS Text Messaging: Connect to Clickatell or Message Media commercial web-based SMS providers using a pre-opened account. These SMS providers will charge for their service and any associated costs are between the service provider and account holder.

Pager: Connect to a pager server using the TAP over IP protocol.



Dynamic User Import Module (DUIM)

This feature allows for users created in another application to be automatically imported into the Integriti software with a predefined set of permissions. It also provides for the automatic modification or deletion of users in the Integriti software if those users are modified or deleted in the other application. User data is easily imported via a CSV file transfer from the third-party system.



Audit Trail

The amazingly powerful forensic audit trail records every programming change made by all operators and provides the ability to “roll-back” to any change in the past.



Modern Client/Server Architecture

Integriti employs a client/server architecture and is fully compatible with the latest computing platforms and Microsoft SQL databases.



Flexible Workstation / Client Options

The Integriti Professional Edition includes an additional 2 client connections with flexible configurations options. Each client can be configured to be “Reserved” for a dedicated workstation, ensuring the Workstation is always available. Alternately Client connections can be “Reserved” for a particular Operator, this ensures the Operator is always able to login regardless of which workstation they are working from. Clients can also be configured to be “Floating”; this allows the client software to be installed on many workstations with up to 2 of them being connected concurrently. Client connections can easily be switched between Floating/Reserved by the system administrator at any time.



Smartphone-Server Interface

The Smartphone-Server Interface allows Apple or Android devices using the Integriti Mobile App to connect to an Integriti Server. This provides a global perspective of the entire security system, particularly useful in managing multi-controller installations from a mobile device.



PhotoID Card Design

The PhotoID feature allows the customised designing and printing of PhotoID access cards. PhotoID printing will also require the use of a compatible third-party card printer (supplied by others).



Unlimited Controller Connections

Integriti Professional allows an unlimited number of Integriti Security Controllers (ISC) and Integriti Access Controllers (IAC) to be connected and centrally managed as one complete system. This allows organisations to expand the security system as needed, either across one location or extended across many geographically disbursed locations.



Business Edition - 996901B

Integriti Business is designed for Medium to Large Businesses, providing additional functionality for every day site security management.

(All functions & features of the Professional Edition are included in the Business Edition)

Features include:



Advanced Reports

While the base package of Integriti Professional includes some basic reporting functionality, the Advanced Reports feature enables customers to generate highly flexible, more detailed, and graphical based reports. Many sample Advanced Reports come standard, such as Contact Trace, Time on Site, Muster, User Access History and many more. For the technically minded, these sample reports can be used as templates to customise and generate other reports according to the needs of the customer. Alternatively, Inner Range offers a professional report writing service with quoted prices varying according to the complexity of the client's requirements.



CCTV Integration & License Plate Recognition (LPR) - Initial 32 Cameras

The CCTV Integration function allows various CCTV & License Plate Recognition (LPR) systems to be integrated into Integriti software and is enabled on a per camera basis. The Integriti Business Edition allows integration of up to 32 cameras, irrespective of the CCTV brand chosen. (extra Cameras can be added in lots of 8 - Part 996921) Please see Inner Range website for a list of compatible CCTV vendors and their respective integration capabilities.



Flexible Workstation / Client Options

The Integriti Business Edition includes an additional 5 client connections with flexible configuration options. Each client can be configured to be "Reserved" for a dedicated workstation, ensuring the Workstation is always available. Alternately Client connections can be "Reserved" for a particular Operator, this ensures the Operator is always able to login regardless of which workstation they are working from. Clients can also be configured to be "Floating"; this allows the client software to be installed on many workstations with up to 5 of them being connected concurrently. Client connections can easily be switched between Floating or Reserved by the system administrator at any time. (Concurrent Client / Workstation connections are shared with Web Server sessions)



Web Server Clients

The Web Client is a mobile friendly, responsive interface which provides access to the Integriti server using a standard web browser on desktop or mobile devices. Up to 5 concurrent Web Client sessions are available with the Integriti Business Edition. (Concurrent Web Client sessions are shared with Client / Workstation connections)



Active Directory Integration (Operators)

This feature enables Active Directory operator integration for Single Sign-On (SSO). Integriti operators are not required to enter an Integriti login username and password as their credentials will be validated with Active Directory based on their Windows login. The Single Sign-On authentication delivers fast and efficient use of the Integriti application. As a further benefit, Active Directory can provide comprehensive password management, including adherence to any global password policies that may have been deployed by the organisation.



Active Directory Integration (Users)

Active Directory Integration for Users allows the synchronisation of Users in the Integriti software with the same Users in Windows Active Directory. New Users and changes to Users in the Active Directory database are synchronised with the Integriti database in accordance with mapping tables which are pre-configured with the import configuration tool within Integriti. The integration is bi-directional, enabling user changes made in within Integriti to be written back to Active Directory. This means that Users need only be entered into one system which reduces operational and training costs, saves time, and improves data consistency.





Corporate Edition - 996901C

Integrati Corporate is designed for Large to Enterprise scale organisations and provides advanced security management features

(All functions & features of the Professional and Business Editions are included in the Corporate Edition)

Features include:



Advanced Alerts - Alarm Escalation, Response Plans & Operator Challenge

Advanced Alerts is intended for use by on-site guards and security managers. It allows a framework within the Integrati software to escalate designated alarms to specific operators and tailor and implement response plans for specific situations. It also enables operator challenge by guards in response to photo pop up on an access event as well as an assortment of other alarm management functionality.



User Qualification Manager

User Qualification Manager is intended to facilitate the implementation of various Workplace Health and Safety criteria by enforcing the currency and renewal of user specific qualifications and permits before access to designated areas will be allowed by the system. Both time-based and credit-based qualifications are supported.



Guard Tour Manager

The Guard Tour Manager is a configurable framework where guard tours can be created, scheduled and monitored in real time. The application offers a high amount of flexibility in the creation of steps, tasks, actions and warnings for each tour. Progress of guard tours can be monitored in real time via Integrati's graphical map interface and via live video feeds from an integrated CCTV system. Warnings and alarms can also be raised where the timing or the expected sequence of events within a tour has not been met. Reports can be generated providing full details of active and completed tours.



Flexible Workstation / Client Options

The Integriti Corporate Edition includes an additional 30 client connections with flexible configurations options. Each client can be configured to be "Reserved" for a dedicated workstation, ensuring the Workstation is always available. Alternately, Client connections can be "Reserved" for a particular Operator, this ensures the Operator is always able to login regardless of which workstation they are working from. Clients can also be configured to be "Floating"; this allows the client software to be installed on many workstations with up to 30 of them being connected concurrently. Client connections can easily be switched between Floating or Reserved by the system administrator at any time. (Concurrent Client / Workstation connections are shared with Web Client sessions)



Web Server Clients

The Web Client is a mobile friendly responsive interface which provides access to the Integriti server using a standard web browser on desktop or mobile devices. Up to 30 concurrent Web Client sessions are available with Integriti Corporate Edition. (Concurrent Web Client sessions are shared with Client / Workstation connections)



CCTV Integration & License Plate Recognition (LPR) - Unlimited Cameras

The CCTV Integration function allows various CCTV & License Plate Recognition (LPR) systems to be integrated into Integriti software. The Integriti Corporate Edition allows integration of an unlimited number of cameras, irrespective of the CCTV brand chosen. Please see Inner Range website for a list of compatible CCTV vendors and their respective integration capabilities.



SNMP & System Health Monitor

The SNMP & System Health Monitor is designed to alert IT administrators to several critical runtime errors that may occur with Integriti or associated SQL server instances. The application provides support for SNMP servers and allows various aspects of the following Integriti functions to be monitored: Active Directory Service, Database, Inner Range IP - Server - Controller communications (IRIP), Reports, Remote Procedure Call (RPC), Scheduler, and Server Services. The SNMP interface is bi-directional, allowing Integriti to generate SNMP traps (alarms) to be received by an SNMP manager or conversely, SNMP traps from third party systems can be sent to Integriti to be processed by Integriti's powerful alarm management sub-system.



The expansion options and features listed below are available for Professional, Business and Corporate Editions and allow the system to be expanded to the customer's requirements.

**Integrati Door License - 996940**

The base packages of Integrati Professional, Business and Corporate include the connection of the first 16 Doors. Additional Door licenses are required (per door), where more than 16 Doors are needed. The Integrati server totals the number Doors across all Controllers that are connected to the server.

**Integrati CCTV Extra 8 Cameras - 996921 (Integrati Business Edition Only)**

The Integrati Business Edition allows integration of up to 32 cameras as standard. This expansion option allows additional Cameras to be added in lots of 8. Please see the Inner Range website for a list of compatible CCTV vendors and their respective integration capabilities.

**Partitioned Systems - 996915**

In an Integrati system Users (and other global entities) are synchronised across all of the hardware Controllers within the system. Partitioning the system allows for entities to exist solely within the partition they were created. Site Partitions can contain multiple Integrati Controllers (ISC) & (IAC) and are entirely isolated from each other while still being managed from a single Integrati Server. For example, each Partition can have its own local 'User 1' - and Card and PIN uniqueness is only enforced within a partition. (One 996915 Partition license is required per-partition)

**Mimic Viewer - 996906**

Mimic Viewer is a software-based mimic panel which is intended to work independently of Integrati. As a stand-alone installation Mimic Viewer is configured to connect directly to an Integrati Security Controller (ISC) or Integrati Access Controller (IAC). Mimic Viewer receives real time status and events directly from the Controller, and displays the status of these events dynamically on graphical maps providing an easy to see representation of alarms and system events to security personnel. (A Professional, Business or Corporate Edition is required for initial setup)

**Inner Range Mobile Reader Application - 996907**

The Inner Range Mobile Reader application is an Android smart-phone app that allows security personnel to visually view and verify cardholder details with a simple scan of a user's access card. The Mobile Reader can be used for on-the-spot identity verification, suspension of access rights and as a "check-in" reader for emergency mustering assembly points. (See page 21 for full details)



Optional Integrations

Optional integration features are available for Integriti Professional, Business or Corporate editions to provide high level communications interfaces between Integriti Software and various third-party products and systems.



3rd Party Door License - 996941

This licence allows the synchronisation of users and access permissions between Integriti and third-party door systems. The Integriti server provides control for both systems which allows operators to utilise it as a single point of administration for all events, users, and doors, including traditional hard-wired doors and wireless locking devices on the third-party system. Third-party doors are licensed on a per door basis.



Mobile Credentials Management Integration - 996964

The Mobile Credential Integration allows Integriti Software to connect to a Mobile Credential provider. This allows Integriti software Operators to allocate and manage Mobile Credentials from within the Integriti User editor. Please see the Inner Range website for a list of compatible Mobile Credential providers.



Event Review I/O Communications - 996931

This software module is in effect a TCP/IP or serial based bi-directional gateway to other systems. This licence allows the Integriti software to send a selected subset of Integriti event data to third party applications. It also allows the Integriti software to receive, process and action event data received from third party systems. The mechanism for this transaction is via an ASCII based text stream.



Locker/Key Locker Integration - 996934

This licence enables a bi-directional integration with various Locker or Key Locker systems. The integration facilitates user database synchronisation between Integriti and the Locker system as well as receiving alarms from the Locker system to leverage Integriti's powerful alarm management capabilities. See the Inner Range website for a full list of integrated Locker / Key Locker systems.



Intercom Integration - 996932

Intercom integration allows operators to manage intercom calls through Integriti software. Intercom calls can be answered, forwarded, initiated or closed with many other features available. Calls appear within the dedicated Intercom Call Queue display in Integriti. To enhance easy of control intercoms can be placed on Integriti maps. See the Inner Range website for a list of compatible Intercoms and their capabilities.

Optional Integrations



Modbus Slave Integration - 996968

The Integrati Modbus TCP Slave service allows certain states of Doors, Inputs, Auxiliaries, and Areas in the Integrati system to be read and written by sending messages from an external "Master" device that supports the Modbus protocol. The service supports mapping Integrati state and control points to Modbus Discrete Inputs and Coils (1-bit data types) respectively. For more detailed information about Modbus – Integrati Integration please refer to the Technical Guide on the Inner Range website (Modbus Input Registers and Holding Registers, 16-bit data types, are not currently supported or implemented)



Visitor Management Integration - 996935

This licence allows a Visitor Management system to push user/visitor information into the Integrati database. The Visitor Management system, therefore, can be the single front-end interface for enrolling visitors with no need to use the Integrati software for such tasks. User/visitor information can include the name, PIN number, card number, access permissions and a variety of other fields. See the Inner Range website for a full list of integrated Visitor Management Systems.



Biometric Management Integration - 996969

Integration between Integrati and Biometric reader management systems allows data such as user names and access permissions to be communicated from Integrati to the Biometric system software. Please see the Inner Range website for a full list of available integrations.



Biometric Export Licence for Morpho Manager Software - 996936

For specific Integration between Integrati Software and MorphoManager software by IDEMIA. For more information on MorphoManager please visit the IDEMIA website: <https://www.idemia.com/morphomanager>

Enterprise Optional Features

The following optional features deliver enterprise level functionality. Some of these features may be more complex to specify or deploy. It is, therefore, Inner Range's recommendation that security professionals consult with the Inner Range sales or support team to assist with the sales or deployment process.



Elevator Management Integration (Lift HLI) - 996933

This licence is required to facilitate a high-level interface between the Integriti server and the Lift server. This interface provides a specific set of functionalities depending on the Lift system and consultation with the Inner Range pre-sales team is therefore required. Inner Range offers high-level lift integration to various vendors other than Schindler however these integrations are enabled in the Integriti hardware controllers with the use of smart card licences. Please consult with the Inner Range pre-sales team for any high-level lift inquiries. Also see page 28 of the Product Catalogue for other lift vendors.



Additional Server Node - HA / Load Spreading - 996965

The Additional Server Node License allows multiple Integriti servers to be deployed and cryptographically paired to a single Integriti Database. Integriti client workstations and controllers can connect to any available Integriti server within the network, allowing for load spreading of larger systems or a high availability solution for the minimisation of potential system downtime and data loss. This solution allows for multiple servers within one location or split-site deployments where off-site disaster recovery solutions are required. It can also be used in conjunction with Microsoft Windows Server Failover Clustering (WSFC) and Microsoft SQL database clustering to create an entirely fault tolerant enterprise level high availability solution.



Milestone Access Control Manager (ACM) Integration - 996939

Integriti's high-level interface with Milestone's ACM is IP-based and bi-directional. ACM integration allows Milestone to be the single master "head end" security management platform, whereby Integriti functions as an access control and security sub-system. Cardholder information, alarms, and events, as well as door and area statuses in Integriti, are sent in real-time to Milestone. Operators are therefore empowered to effectively manage their security operation by seamlessly monitoring Integriti alarm and access points through Milestone. Operators may also unlock/lock doors and control areas with the added ability to associate doors and areas to cameras in Milestone, thus facilitating efficient situational awareness and immediate visual verification of alarms.



Real-Time Location System (RTLS) Integration - 996928

The RTLS integration allows the Integriti server to integrate with several RTLS providers. Locations of users and assets can be displayed within Integriti Schematic Maps or using Area and User filters. Alarm and Event information can be received and displayed in Integriti Review and Integriti can process the information in its automation and alarm management infrastructure. Please see Inner Range website for a list of compatible Real-Time Location Systems and their respective integration capabilities.



Active User Rotation (AURM) - 996956

This licence is used when there are more users in the software than the 100,000 that can be accommodated in the hardware Controllers. If this licence is deployed and a user presents their card to any reader in the system, but that user record cannot be found in the database of the local Controller, the Controller will interrogate the Integrati server to see if the user exists in the software database. If the user is valid in the software database, then access is granted immediately, and that user and their permissions are downloaded to that specific Controller overwriting the oldest user in that Controller.



VingCard Integration - VingCard as Master - 996937

VingCard is a system often deployed to provide access control for guests checking into rooms in hotels or apartment complexes. In facilities such as these, the Integrati system is also deployed to provide real-time monitored access control for the base building elements such as elevators, staff doors, service doors and car parks. Integration between VingCard and Integrati allows user card data to be sent from VingCard to Integrati, allowing guest or tenant access to doors managed by Integrati (such as lifts, perimeter doors, etc.)



XML API Integration

An XML licence is a mechanism which allows a third-party software writer to create a software product which can access the database of the Integrati software directly. This is done through a controlled XML/REST portal in the Integrati software designed specifically for this purpose. XML (Extensible Markup Language) is an IT industry standard language/protocol for the transmission of data between software applications.

XML licences can only be purchased after a Technology Partner Agreement has been executed by Inner Range and the potential developer. An application to become a Technology Partner with Inner Range can be made using the appropriate application form and requires a binding disclosure of the scope and purpose of the integration. Any XML interface licence issued can only be utilised for the purpose defined in the partner agreement.

XML Interface - READ - 996950 | XML Interface - WRITE - 996951 | XML Interface - CONTROL - 996952



Enterprise Optional Features



Inner Range Mobile Reader Application - 996907

The Inner Range Mobile Reader is an Android smartphone application that allows security personnel to view and verify cardholder details with a simple scan of a user's access card. Mobile Reader can be used for on-the-spot identity verification, suspension of access cards and as a "check-in" reader at emergency mustering assembly points.

Mobile Reader Main Features

- User Identification & Location Check:** On presentation of a valid card, Mobile Reader displays the user photo, user location, card status and additional user and card information. The information displayed can be configured from the Integriti server to include any user properties, card properties and custom fields such as Employee ID, Student ID, and Department. Mobile Reader can be set to the specific location or area where the smartphone is located. When user information is displayed, the user's location will be displayed in red if it does not match the device location. This allows security personnel to identify users that may have entered areas without authorisation.
- Suspending Cards:** If a user doesn't match the cardholder photo, security personnel can immediately suspend the card from the Mobile Reader application. The suspended card will no longer provide access to any doors until reactivated from the Integriti server.
- Emergency Muster:** In the event of an emergency, Mobile Reader can be used as a "check-in" reader at an emergency mustering assembly point. The operator can select a muster point location and areas that are being evacuated. Multiple smartphones running Mobile Reader can be used collaboratively during an emergency evacuation. As users present their cards at the "check-in" reader, their location is updated to the muster point. In muster mode, the app displays the number of users still inside the evacuation areas, the number of users at the muster point and the total number of users at all muster points. Mobile Reader provides a scrollable list of all users still inside an area or building as well as their last known location. Additionally, an operator can search for users by name to quickly determine their last known location. Access to this critical information provides emergency services with accurate information for a focused and timely response.



User Verification Features

- Display user photo, user location, card status and additional user and card information
- Display user and card custom fields
- Verify user location against device location
- Suspend user access cards

Muster Features

- Functions as a "check-in" reader at emergency mustering assembly points
- Supports multi-device coordinated mustering
- Selectable muster location
- Selectable evacuation areas and locations
- Dynamically displays the number of users still inside the evacuation areas, the number of users at the muster point and the total number of users at all muster points
- Scrollable list of users still inside the evacuation areas and their last known location
- User name search

Application Features

- Supports username and password login or biometric fingerprint login
- Displayed user and card information is configurable from the Integriti server
- Areas and locations can be grouped into Location Lists for site-wide mustering

Requirements

- Integriti Professional V18.1 or newer
- Android V7.0 Nougat or newer
- Smartphone with NFC capabilities
- Supports Inner Range SIFER and HID MIFARE DESFire© EV1 & EV2 cards.**
- Inner Range Mobile Reader – 996907 is licenced per mobile device connected to the Integriti server. Connected devices can be managed, activated or deactivated from the Integriti server.

**Requires SIFER Enrollment Station to identify card serial numbers of SIFER credentials.

Ordering Options

996907
Inner Range Mobile Reader Application
(one required per smartphone)





Express Edition - 996905

Integriti Express is a budget focused software solution for Small and Medium Business's (SMBs). Express is a great option for sites that do not need the advanced features of the Professional version. The following base level parameters are included with the Integriti Express Product Key:

1. Connection of one Client Workstation where the client workstation and server are the same machine
2. Connection of one Integriti Controller (ISC or IAC)
3. Support for up to 16 Doors



Some of the features included with Integriti Express:



User/Cardholder Management

The incredibly flexible user permissions provide an easy-to-use, building block method of assigning access and security rights to cardholders. Cardholder profiles are easily created by assigning multiple permissions with simple "Allow" and "Deny" functions.



System Health Monitoring

Monitor the health of both the Integriti hardware and software. Proactive notifications can alert security operators and security contractors if maintenance is required.



Basic Reporting

Single-click reporting to review the areas cardholders have accessed, what areas cardholders have access to, search event and alarm history, programming history and much more. Easily export reports in a variety of common file formats.



SkyTunnel Connectivity

SkyTunnel is an industry-first cloud-based service that provides hassle-free connectivity of Integriti hardware, software and mobile apps.



System Designer and GateKeeper Applications

System Designer is used for all aspects of system programming and configuration. GateKeeper is a dedicated application to simplify day to day monitoring and control of the Integriti system.



Intuitive Design

The Integriti System Management Suite is a true cutting-edge solution. Integriti boasts a contemporary and intuitive design that is simple to use and easy to learn.



Operator Permissions

Manage the operators that use Integriti software. Easily customise and define their access permissions levels with fine control.



Upgrade to Integriti Professional - 996905UPG

Express can be upgraded to Integriti Professional at any time.



Audit Trail

The amazingly powerful forensic audit trail records every programming change made by all operators and provides the ability to "roll-back" to any change in the past.

Express software provides one connection to an Integriti Controller supporting up to 16 doors and can be used only on a single computer workstation. Express offers all the essential functionality required to configure, administer and monitor a single Integriti system. Full operator permissions are provided for added security and Integriti Express can be upgraded to Professional if and when further expansion is required.

Commissioning Software

Integriti Commissioning Software (CS) is a software application designed to be used by installation technicians when they are installing and commissioning Integriti Controllers.

CS can be used to bench program Controllers prior to deployment and to train and familiarise technicians with general Integriti programming techniques.

The Integriti CS application is available as a yearly expiring licence to approved technicians only. This approval is usually granted after appropriate factory accreditation has been undertaken successfully and a level of competency with the Integriti platform has been certified by the Inner Range training department.



Integriti Software Comparison

| Features | CS | Express | Pro | Business | Corporate |
|--|----------------|----------------|---------------|---------------|---------------|
| User Management, System Programming, System Status, Programming History (Audit Trail) | ✓ | ✓ | ✓ | ✓ | ✓ |
| Hassle Free IP Connection with SkyTunnel. ^a | ✓ | ✓ | ✓ | ✓ | ✓ |
| Software Operator Permissions | ✗ | ✓ | ✓ | ✓ | ✓ |
| GateKeeper – A Dedicated Application for Daily End User Operations | ✗ | ✓ | ✓ | ✓ | ✓ |
| Additional Workstations / Clients (Floating or Fixed) | ✗ | ✗ | ✓(2) | ✓(5) | ✓(30) |
| Support for Multiple Controllers | ✗ | ✗ | ✓ | ✓ | ✓ |
| Schematic Graphical Maps with Scalable Vector based graphics | ✗ | ✗ | ✓ | ✓ | ✓ |
| Alarm Management | ✗ | ✗ | ✓ | ✓ | ✓ |
| Smartphone-Server Interface | ✗ | ✗ | ✓ | ✓ | ✓ |
| Communicator - Email, SMS & Pager | ✗ | ✗ | ✓ | ✓ | ✓ |
| Photo ID Card Design | ✗ | ✗ | ✓ | ✓ | ✓ |
| Dynamic User Import Module (DUIM) | ✗ | ✗ | ✓ | ✓ | ✓ |
| Advanced Reports | ✗ | ✗ | ✗ | ✓ | ✓ |
| Web-based Client for Desktop or Mobile Devices (Responsive) | ✗ | ✗ | ✗ | ✓ | ✓ |
| CCTV Integration. ^b | ✗ | ✗ | ✗ | ✓(32) | ✓(Unlimited) |
| CCTV Licence Plate Recognition Integration | ✗ | ✗ | ✗ | ✓ | ✓ |
| Active Directory Integration - Operators | ✗ | ✗ | ✗ | ✓ | ✓ |
| Active Directory Integration - Users | ✗ | ✗ | ✗ | ✓ | ✓ |
| User Qualifications Manager | ✗ | ✗ | ✗ | ✗ | ✓ |
| Advanced Alarm Management, Alarm Escalation, Response Plans & Operator Challenge. ^c | ✗ | ✗ | ✗ | ✗ | ✓ |
| SNMP & Health Monitor | ✗ | ✗ | ✗ | ✗ | ✓ |
| Guard Tour Manager | ✗ | ✗ | ✗ | ✗ | ✓ |
| 3rd Party Door Integration | ✗ | ✗ | Optional | Optional | Optional |
| Event Review I/O Communications | ✗ | ✗ | Optional | Optional | Optional |
| Milestone XProtect Access ACM Integration | ✗ | ✗ | Optional | Optional | Optional |
| Mobile Credential Management Integration | ✗ | ✗ | Optional | Optional | Optional |
| Modbus BMS Integration | ✗ | ✗ | Optional | Optional | Optional |
| KeyLocker / Locker Integration | ✗ | ✗ | Optional | Optional | Optional |
| Elevator Management Integration (Lift HLI) | ✗ | ✗ | Optional | Optional | Optional |
| Additional Server Node - HA / Load Spreading | ✗ | ✗ | Optional | Optional | Optional |
| Inner Range Mobile Reader Application | ✗ | ✗ | Optional | Optional | Optional |
| Biometric Management Integration | ✗ | ✗ | Optional | Optional | Optional |
| Intercom Integration | ✗ | ✗ | Optional | Optional | Optional |
| Visitor Management Integration | ✗ | ✗ | Optional | Optional | Optional |
| VingCard Integration | ✗ | ✗ | Optional | Optional | Optional |
| RightCrowd Enterprise Integration | ✗ | ✗ | Optional | Optional | Optional |
| Real-Time Location System (RTLS) Integration | ✗ | ✗ | Optional | Optional | Optional |
| Active User Rotation Module (AURM) | ✗ | ✗ | Optional | Optional | Optional |
| XML Integration (Technology Partner Program) | ✗ | ✗ | Optional | Optional | Optional |
| Software Dimensions | CS | Express | Pro | | |
| Number of Controllers Supported. ^d | No Limit | 1 | No Limit | No Limit | No Limit |
| Number of Simultaneous Controller Connections. ^d | 1 | 1 | No Limit | No Limit | No Limit |
| Number of Doors Supported | 250 | 16 | 16 ~ No Limit | 16 ~ No Limit | 16 ~ No Limit |
| Permitted Software Use | Installer Only | End User | End User | End User | End User |

a. - SkyTunnel provides non-permanent connections between Integriti Controllers, Integriti software and the Integriti Mobile App.

b. - Business Edition includes 32 Cameras, which can be expanded further.

c. - Basic alert functionality is included as standard with the Professional & Business Editions. However, advanced alert functions such as Response Plans, Alert Escalations, Alert Reporting and Operator Challenge requires the Corporate Edition.

d. - Depending on the size and activity level of the system multiple servers may be required to support extremely large numbers of Controllers.

Hardware

Hardware



Three main hardware components make up an Integrati system:

1 - Controllers

2 - Field Modules (via RS-485 or IP LAN)

3 - Local Expansion Devices (via UniBus)

Integrati Security Controller (ISC)

The Integrati Security Controller is a state-of-the-art IP-based integrated Security and Access controller with powerful embedded processors and extensive on-board memory. The ISC is equipped with 16 Zone Inputs, 2 Auxiliary Relay Outputs, Power Supply with Smart Fuses, Siren and Watchdog Outputs, Ethernet, USB and Modem ports. The ISC can be used both standalone or expanded further via its local UniBus and RS-485 Sub-LAN ports.

The flexible, modular design of the ISC allows a single standalone Controller to be expanded to form a network of IP or RS-485 expansion modules supporting up to 3,000 Zone Inputs, 3,000 Outputs, 250 Areas and over 1,000 Card Readers and 250 Doors. User capacity of up to 100,000 users is available, and capacity for 1,000,000 users is also available with the User expansion kit. Peer to Peer communications between ISC controllers is also supported.



1 - Controller

Integrati Access Controller (IAC)

The Integrati Access Controller (IAC) is a state-of-the-art IP connected Intelligent Controller. Designed for Access Control applications, the IAC directly manages up to 8 doors locally or 250 doors via RS-485 Sub-LAN expansion. All decision making is intelligently processed by the Controller with no reliance on the system server (should the connection to the server be offline). The result is a solution that is incredibly quick, robust and highly available.

The flexible, modular design of the IAC allows a single standalone Controller to be expanded to form a network of IP or RS-485 expansion modules supporting up to 3,000 Zone Inputs, 3,000 Outputs, 250 Areas and over 1,000 Card Readers and 250 Doors. User capacity of up to 100,000 users is available, and capacity for 1,000,000 users is also available with the User expansion kit. Peer to Peer communications between IAC controllers is also supported.



1 - Controller

Integrati Intelligent LAN Access Module (ILAM)

The ILAM can be used to control and monitor up to 8 Doors or Lift access readers on the Integrati RS-485 LAN, or via IP LAN if connected using Ethernet Bridge or CLOE devices. The base module supports 2 Doors and 2 Wiegand Card Readers or 16 Inner Range SIFER Card Readers. The ILAM is expandable up to 8 Doors and 8 Wiegand Card Readers with the simple addition of UniBus 2 Door/2 Reader Expanders.

The ILAM offers a complete suite of programmable options to provide advanced high security access control, security area control and door alarm monitoring functions. Offline intelligence is also provided via the on-board database to provide access control functionality and event logging even if communications to the master Controller (ISC or IAC) are severed. Upon re-connection, all buffered events and any programming changes are automatically synchronised with the master Controller.

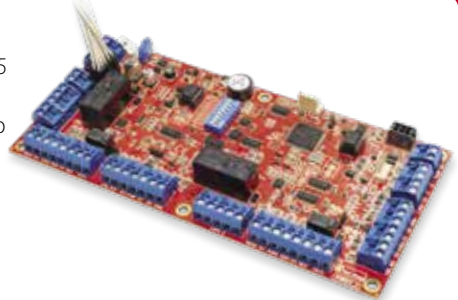

2 - Field Module

Integrati Standard LAN Access Module (SLAM)

The Integrati Standard LAN Access Module (SLAM) can be used to control and monitor up to 2 Doors on the Integrati RS-485 LAN, or via IP LAN if connected using Ethernet Bridge or CLOE devices.

The module supports 2 doors and up to 4 Inner Range RS-485 SIFER readers to accommodate entry and exit readers on both doors. Alternatively, two Wiegand readers may be connected to allow control and monitoring of a single door with entry and exit readers, or two doors with a single reader each.

The SLAM offers cached functionality via its on-board database to provide offline access control operation for up to 2,000 user cards if communications to the master Controller (ISC or IAC) are lost. Cache expiry time for the module can be selected ranging from 1 hour to 4 months. In addition, each user has an option to be stored permanently within the modules cache, particularly useful for situations where certain staff may need to be guaranteed access at all times.

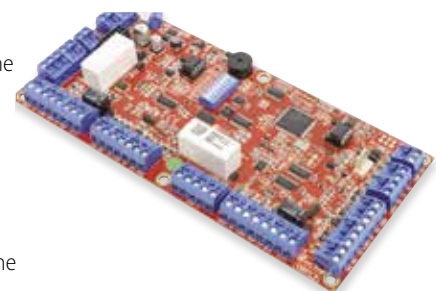

2 - Field Module

Integrati 8 Zone LAN I/O Expander (Expandable to 32 Inputs/Outputs)

The Integrati 8 Zone LAN Expander Module connects directly to the Integrati RS-485 LAN and provides an additional 8 Zone Inputs, 2 Auxiliary Outputs and 2 Siren drivers (Siren drivers fitted from PCB revision 'B'). Up to 99 Zone Expander Modules can be connected to the Integrati RS-485 LAN or via IP LAN if connected using Ethernet Bridge or CLOE devices.

The 8 Zone LAN Expander Module also offers a UniBus in-cabinet expansion interface, allowing further expansion of Zone Inputs and Auxiliary Outputs using plug on UniBus expansion devices fitted within the same tamper-protected enclosure. Up to 32 Zone Inputs or 32 Auxiliary Outputs can be connected to the Module (32 Zones and 26 Auxiliaries or 24 Zones and 32 Auxiliaries simultaneously).



2 - Field Module

Integrati PrismaX Keypad

The Integrati PrismaX Keypad provides a stylish and simple keypad to control the Integrati system. End users can perform simple functions such as arming and disarming areas, locking or unlocking doors and reviewing event history via the full-colour graphic display. Installers also have the ability to program many of the major features of the Integrati system from the convenience of a PrismaX Keypad.

An optional SIFER reader add-on board can be fitted to the PrismaX keypad in order to support card access via the Keypad or high-security environments which require dual credential "card+PIN" access.



2 - Field Module

UniBus Expansion

UniBus is an innovative in-cabinet bus which allows the connection of Expansion devices, Communications devices and Door & Reader devices on a common Plug & Play bus. UniBus replaces the need for ribbon cables and specialised connectors.

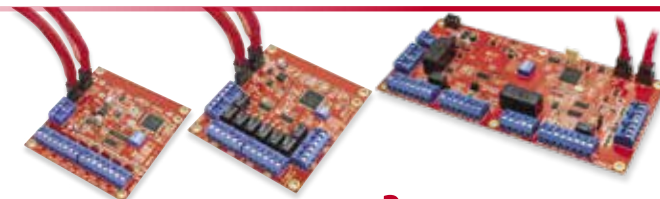

3 - Local Expansion

Inner Range SIFER Smart Card Readers & Keypads

The SIFER Smart Card Reader is a multi-drop RS-485 reader for use with MIFARE® based cards, including the high-security Inner Range MIFARE® DESFire® EV1/EV2 cards. SIFER readers and cards deliver AES encryption right through to the Access Module, offering far superior security than traditional Wiegand based readers. As SIFER readers utilise a superset of the OSDP protocol, the readers may also be deployed on any system capable of using OSDP. Up to 16 SIFER readers may be connected to the dedicated RS-485 reader port on the Integrati Intelligent LAN Access Module (ILAM) or the Integrati Access Controller (IAC) for full Reader-In and Reader-Out operation. Up to 4 SIFER readers may be connected to the Integrati Standard LAN Access Module (SLAM). SIFER readers and Keypads are IP67 rated and available with site-specific encryption keys.



3 - Local Expansion

SkyTunnel

SkyTunnel is an industry-first cloud-based service that provides hassle-free connection of Integrati hardware, software and Integrati Mobile Apps over the Internet. No more wasted hours configuring routers and ports. The SkyTunnel service also allows Integrati Controllers to report alarms via IP directly to Multipath-IP or Patriot equipped monitoring centres without any additional STU hardware or PSTN connections.



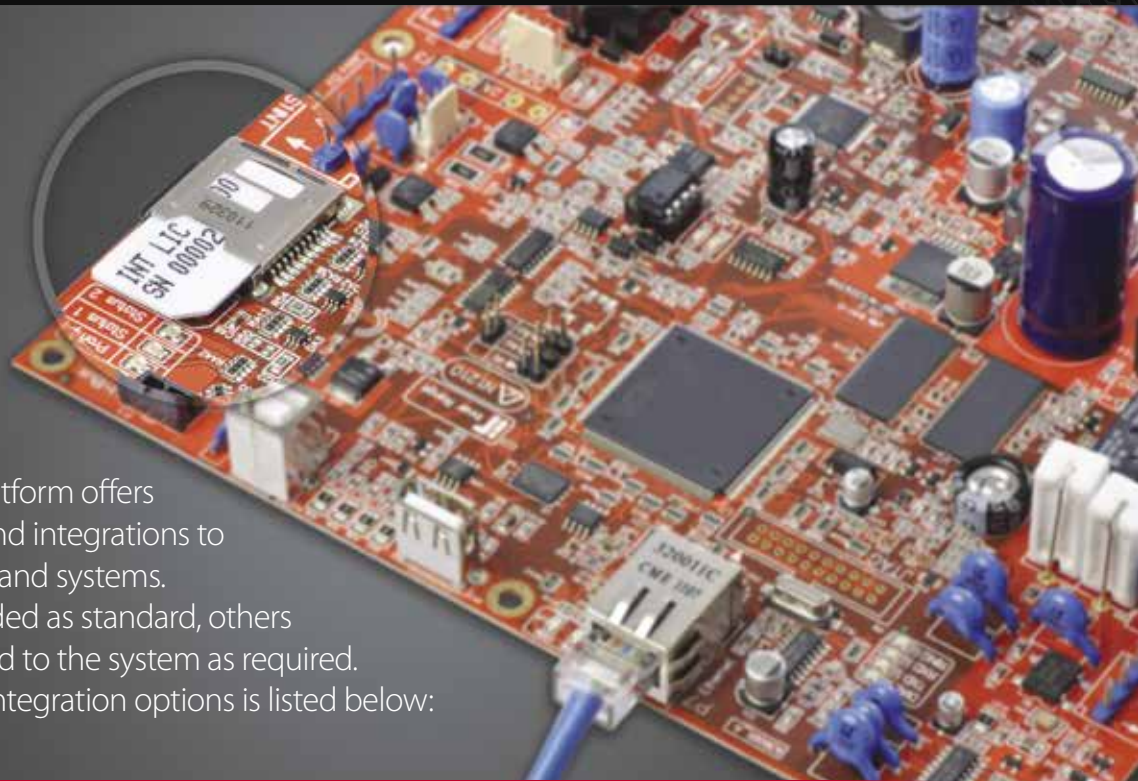

The Integriti hardware platform offers hardware level features and integrations to many 3rd party products and systems. Several features are included as standard, others can be ordered and added to the system as required. A full list of features and Integration options is listed below:

Integrations & Features included as standard: (Version 20 or later Firmware required)



Wireless Door Integration

Wireless door products such as Assa Abloy Aperio, SimonsVoss or Salto Sallis can be integrated with the Integriti system hardware. Integration is achieved via a direct connection between the 3rd party Wireless Door Control Hub and Integriti Access Control hardware. Up to 8 doors can be integrated per Integriti Access Controller (IAC) or Intelligent LAN Access Module (ILAM), or 2 doors with the Standard LAN Access Module (SLAM). (Up to 250 wireless or wired doors can be connected to each ISC/IAC controller sub-LAN)



Smartphone-Controller Interface for Integriti Mobile App

The Smartphone-Controller Interface allows Apple or Android devices using the Integriti Mobile App to connect directly to Integriti ISC/IAC Controllers providing convenient control of the system from a mobile device.

Alternately the Integriti Mobile App can be connected to Integriti Professional, Business or Corporate Edition Software to manage systems where multiple controllers are used.



Virtual Expansion Modules

Up to 99 Virtual Expander modules can be used on each Integriti Controller (ISC/IAC) with each module providing an additional 32 zone inputs and 32 auxiliary outputs to be used for logic/automation control. (i.e up to 3168 logical inputs & outputs) This negates the need to install physical expander modules where inputs and outputs are only used for logic control purposes.



C-Bus Lighting High-Level Interface

The C-Bus interface supports the integration of a Clipsal C-Bus lighting control system to an Integriti Controller (ISC/IAC). Integration to C-Bus allows fully automated control of lighting systems for energy management and security purposes. The connection uses TCP/IP or RS232 serial between the Integriti Controller and the Clipsal Network Interface (CNI).



Locker Bank Control

Locker Bank Control allows an Integriti Controller (ISC/IAC) to control electronic locks in a logical fashion for various locker scenarios. A single Controller can support up to 1000 lockers and the quantity of lockers per bank can be customised to suit the customer's requirements using one of three supported modes: 1 - Predefined Access Mode, 2 - Dynamic "One Per User" Mode, 3 - Dynamic "Unlimited" Mode, Locker bank functionality is used in conjunction with Integriti access control modules and card readers.

Optional Features



ASCII Automation Interface - 996022

The ASCII Automation Interface allows an Integrati Controller (ISC/IAC) to connect to a 3rd party Home or Building Management System via a TCP/IP or RS232 serial connection. The interface uses a full-duplex ASCII based protocol delivering a flexible and easy to integrate solution. Integrati's Standard and Advanced level automation interface features are included with this option.



Modbus BMS Interface - 996228M (Also used for BACnet/IP)

This licence allows Integrati's built-in Modbus communications interface to be activated and configured to communicate directly with ModBus BMS systems. The same option should also be used for BACnet/IP integration, however a third party hardware based protocol converter will also need to be used - please consult the Inner Range pre-sales design team for further information.



Elevator Management System High-Level Interface - 996023

This licence allows an Integrati Controller (ISC/IAC) to integrate with a variety of lift manufacturers. This licence can only be issued in consultation with and through the Inner Range pre-sales design team and their professional services will be required to program the interface. Interface protocols available at the time of writing are Mitsubishi, KONE, OTIS and ThyssenKrupp, although not all models of each manufacturer are supported. Check with the Inner Range pre-sales design team before committing to any particular interface. (High-Level Schindler Lift Integration is achieved using a licence in the Integrati Software - see page 19 of the Product Catalogue)



Honeywell Fire Panel Integration - 996239

Integration with the Honeywell Fire Panel is a simplistic "event receiver" method which allows an Integrati Controller (ISC/IAC) to receive alarm events directly from the Honeywell fire panel's serial printer interface when they occur. This integration is suitable to trigger alerts and actions within the Integrati system as they are received, however monitoring the real-time status of alarm points is not supported.

For detailed technical information please refer to the Honeywell fire system integration guide.

Optional Features



High Security Fence IP High-Level Interface - 996025

This licence will allow integration between an Integrati Controller (ISC/IAC) and a high security fence system. The integration allows the fence system to be monitored and controlled directly from the Integrati software. Dynamic fence icons may be used to graphically represent fence zones and other fence objects within Integrati's software schematics. For a full list of High Security Fence integrations, please see the Inner Range Website.



Advanced Peer-to-Peer Functionality - 996030

Peer-to-Peer describes the communication functionality that exists directly between Controllers without any dependency upon the Integrati server. This provides superior levels of continued operation in the event that the Integrati server is offline. Peer-to-Peer functionality is used to deliver the following features:

- 1. Controller to Controller alarm reporting.** Alarms may be routed from multiple Controllers to a single Controller that can report the alarms to a monitoring station.
- 2. Global anti-passback.** Allows door anti-passback logic to span doors that are connected to two or more separate Controllers.
- 3. Cross-Controller logic mapping.** Allows conditional logic to operate across inputs, outputs and system objects resident on two or more separate

Controllers. Option 1 is included as standard in all Integrati ISC/IAC Controller. Options 2 & 3 are enabled with the 996030 Advanced Peer-to-Peer licence in each Controller.



| Main Controller Features | Security Controller | Access Controller |
|---|---------------------|-------------------|
| Power Supply On-Board (Powered with 16VAC) | Y | N ⁽¹⁾ |
| Connector for External SMART PSU (13.75VDC PSU) | N | Y |
| Connection for Battery | Y | N |
| Detector Power Connections | Y | N |
| PSTN Dialler On-Board | Y | N ⁽²⁾ |
| Ethernet IP Reporting on Multipath-IP Network | Y | Y |
| General Purpose Zone Inputs | 16 | - |
| General Purpose Relay Outputs | 2 | - |
| Siren Driver Outputs (Speaker) | 2 | - |
| Door Lock Relay Outputs | - | 2 |
| DOTL Relay Outputs | - | 2 |
| Wiegand Reader Connection Ports | - | 4 |
| Valid Read Outputs | - | 4 |
| Invalid Read Outputs | - | 4 |
| Arm Input | - | 4 |
| Request Exit Input | - | 2 |
| Request Entry Input | - | 2 |
| Door Reed Input | - | 2 |
| Door Tongue Sense Input | - | 2 |
| Cabinet Tamper Input | 1 | 1 |
| Watchdog Output | 1 | 1 |
| UniBus Host | Y | Y |
| USB Ports | Y | Y |
| Ethernet Port | Y | Y |
| Serial Port (Port Zero) | Y | Y |
| RS-485 Module LAN Port | Y | Y |
| RS-485 Reader LAN Port | - | Y |

| Smart Card Levels & Licences Supported | Security Controller | Access Controller |
|--|---------------------|-------------------|
| Smart Card Fitted as Standard | Y | Y |
| Support for User Expansion Kit (Allows 1,000,000 Users on-board) | Y | Y |
| Smart Card Additional Licences (All Types) | Y | Y |

| RS-485 Module LAN Expansion | Security Controller | Access Controller |
|---|---------------------|--------------------|
| Maximum Module Count on LAN | 250 | 250 |
| Maximum Modules of Any One Type | 99 | 99 |
| Integrati & Concept RS-485 Module Types Supported | All ⁽³⁾ | All ⁽³⁾ |

| Controller - UniBus Device Support | Security Controller | Access Controller |
|------------------------------------|---------------------|----------------------------|
| UniBus 8 Input Expander | Y - up to 2 | - |
| UniBus 8 Relay Expander | Y - up to 4 | Y - up to 2 ⁽⁴⁾ |
| UniBus 2 Door Expander | - | Y - up to 3 |
| UniBus RS-232 / RS-485 UART | Y - up to 4 | Y - up to 4 |
| UniBus 16 Floor Lift Interface | Y - up to 6 | Y - up to 6 |
| UniBus 4 Analogue | Y - up to 4 | - |

⁽¹⁾ Use Integrati 3Amp or 8Amp SMART Power Supplies with IAC

⁽²⁾ Use Peer-to-Peer to forward alarms to a dialler on an ISC. Alternately use a T4000 4G Communicator

⁽³⁾ Older Concept modules may not be supported or original functions may differ. Concept Touchscreen not supported

⁽⁴⁾ UniBus relays can be used for general purpose outputs when addressed to Aux 1~16 on IAC, but cannot be mapped to Aux 17~32

The Integrati Security Controller (ISC) is an IP-based master controller for the Integrati modular hardware system. Equipped with 16 Zone Inputs, 2 Auxiliary Relay Outputs, Power Supply, Ethernet Port, Modem, and Internal/External Siren outputs, the ISC can be used either stand-alone or expanded further via its UniBus and RS-485 Sub-LAN ports. The flexible, modular design of the ISC allows a single stand-alone controller to be expanded to form a network of IP or RS-485 expansion modules supporting up to 3,000 Zone Inputs, 3,000 Outputs, 250 Areas and over 1,000 Card Readers and 250 Doors. User capacity of up to 100,000 users is available, and capacity for 1,000,000 users is also available with the User Expansion Kit (Part. 996002L5).

The ISC also offers a UniBus in-cabinet expansion interface where a variety of UniBus I/O and communications devices can be connected directly to the controller and housed within the same tamper-protected enclosure. Integrati's multi-controller architecture allows any number of ISC's to be combined within the Integrati software package to form a globally managed small, medium or enterprise sized system where the entire network of controllers is managed as a whole. This architecture allows for an infinite number of Readers, Doors, Areas, Zone Inputs and Outputs.

ISC Controller RS-485 LAN Expansion

Further expansion and functionality is realised with the addition of sub-LAN expansion modules which are connected to the Integrati Security Controller via the RS-485 LAN. These modules can also be connected via standard Ethernet networks if connected using Ethernet Bridge or CLOE devices.



Main Controller Features

- RJ45 - 10/100 Ethernet Port
- RS-485 Sub-LAN
- USB Master & Slave Ports
- UniBus In-Cabinet Expansion Interface
- Multipath-IP / GSM STU Port (Port Zero RS-232)
- 16 Zone Inputs - Multistate or Analogue
- 2 Auxiliary Output Relays & separate Watch Dog Output
- Dedicated Tamper Input
- Internal & External Siren Outputs
- RJ-12 PSTN Dialler/Modem Connection
- Intelligent Power Control via Smart Fuses
- 32 Bit ARM CPU with Real Time Clock
- 64 MB RAM / 4 GB Micro SD Memory
- Smart Card Slot
- Firmware Upgrade via USB, LAN or Software

Ethernet Connected Services

- Connectivity to Integrati Software
- SkyTunnel® Cloud Services & Smart Phone connectivity
- Peer to Peer communications
- Automation Interface
- BMS / HVAC Integration
- EMS / Lift Access Control Integration

Hardware Expansion Capabilities

- Zone Inputs - Expandable to 32 via UniBus – 3,000 via RS-485 Sub-LAN
- Auxiliary Outputs - Expandable to 32 via UniBus – 3,232 via RS-485 Sub-LAN
- Doors – Expandable to 250 via RS-485 Sub-LAN
- Readers - Expandable to 1,584 via RS-485 Sub-LAN
- On-board User capacity - 100,000, 1,000,000 with User Expansion Kit fitted
- On-board Review Events - 100,000
- Ports - RS-232 / RS-485 Serial Ports - Expandable to 8 with UniBus UART

Integrati ISC Standard Operating Level

- 250 Doors, 3,000 Zones, 100,000 Users, 100,000 Events

| UniBus Device Compatibility Guide | UniBus Host Module | | | |
|-----------------------------------|--------------------|-----|-----------------|------|
| | ISC | IAC | 8 Zone Expander | ILAM |
| 8 Zone Expander | 2 | 0 | 3 | 0 |
| 8 Relay Expander | 4 | 2 | 4 | 2 |
| 2 Door / 2 Reader Expander | 0 | 3 | 0 | 3 |
| 16 Floor Lift Interface | 6 | 6 | 6 | 6 |
| RS-232/RS-485 UART | 4 | 4 | 0 | 0 |
| Analogue Expander | 4 | 0 | 6 | 0 |

Connectivity

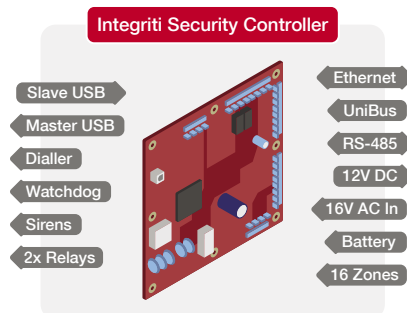

Integrati Security Controller Architecture

The ISC directly supports up to 32 Inputs and 32 Outputs with further I/O expansion and access control via the RS-485 Sub-LAN

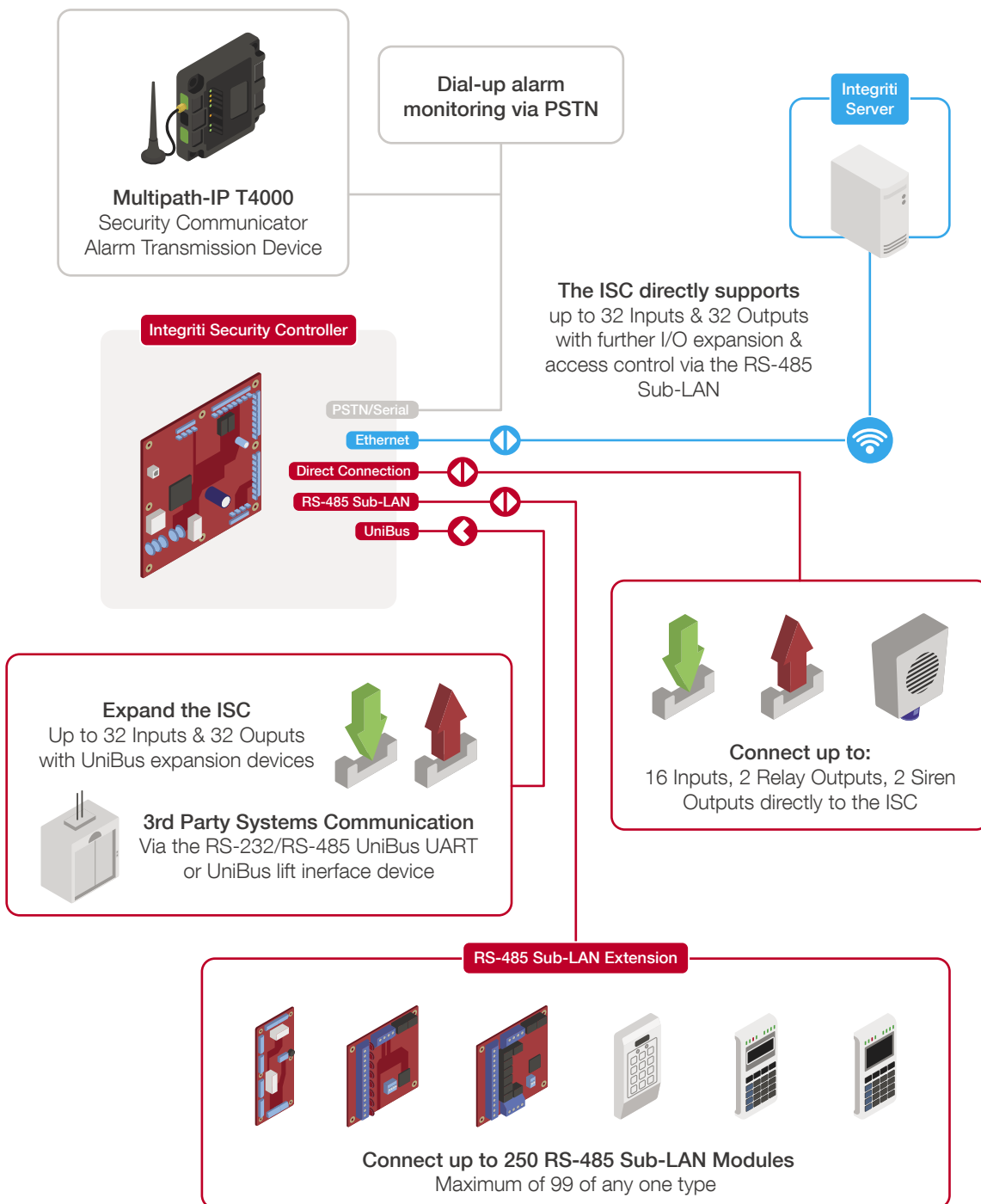

Specifications

Physical

| | |
|---------------------------|--|
| Enclosure Dimensions: | Medium size enclosure 460(L) x 358(W) x 85(D) (mm) |
| PCB Dimensions: | 200(L) x 200(W) x 45(D) (mm) |
| Shipping Weight : | 6.5kg (In medium enclosure with mains transformer and cover) |
| Installation Environment: | 0°C - 50°C @15% - 90% Relative humidity (non-condensing) |
| Cabinet Battery Bracket: | To suit 12V 7AH sealed lead acid battery |

Electrical

| | |
|---|--|
| Power Supply Type: | Type A (EN50131-1) |
| Transformer Input Voltage: | 240V AC -10% / +10%. 50Hertz |
| Transformer Output: | 16.5V AC. 50 Hertz |
| Current Consumption: | Maximum 500 mA from 240V AC Source |
| Fuse Protection: | Separate AC mains input fuse. 1.0 AMP Slow Blow M205 (20mm) |
| PCB AC Input Voltage: | 16 to 18V AC. 50/60 Hertz |
| Battery Charger Output: | 13.75VDC -0.15/+0.05 V (AC power required) |
| 12V, Sealed Battery Capacity: | Use 7.2AH or 18AH Lead Acid Type: Max 18AH |
| Battery Input Fuse: | 5 Amperes |
| Low Battery Alarm: | < 11V DC +/- 100mV |
| Deep Discharge Protection: | Activates at 10.4V +/-100mV. Restores at 12.4V +/- 100mV |
| LAN*POS* & DET+: | Output Voltage: 13.75V DC -0.15/+0.05 V (When AC power Present) |
| LAN*POS* & DET+ Smartfuse trip current: | 2 Amperes |
| Maximum Ripple: | At maximum ancillary load current: < 200mV P-P / 75mV RMS |
| Low DC Voltage Alarm: | < 11V DC +/- 100mV |
| Siren Drivers: | Each capable of driving a 4 Ohm speaker (or 2 x 8 Ohm in parallel) |

RS-485 & UniBus Parameters

| | |
|------------------------------|--|
| UniBus In-Cabinet Expansion: | Up to 6 UniBus devices |
| RS-485 Sub-LAN: | Up to 250 RS-485 Sub-LAN Modules (maximum of 99 of any one type) |

Current Consumption

| AC Source | JPS Setting | Total Current Limit | Static Controller Current | Battery Capacity | Max Ancillary Current |
|-----------------|-------------|---------------------|---------------------------|------------------|-----------------------|
| 1.5A Plug Pack: | Not shorted | 1.3 AMP | 275mA | 7 AH | 700mA |
| Transformer: | Shorted | 2.2 AMP | 275mA | 7 AH | 1.2A |
| Transformer: | Shorted | 2.2 AMP | 275mA | 18 AH | 480mA |

Compliance

| | | | |
|---------------|--|--|--|
| Electrical | | | |
| Environmental | | | |

Ordering Options



Integrati ISC in Medium Enclosure
996001AUPS



Integrati ISC PCB & Accessories
996001AUPCB&K



996002L5
Level 5 User Expansion Kit for
ISC/IAC (one million users)

Ordering Options - UniBus Devices for ISC

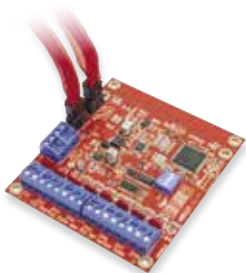

996500PCB&K
Integrati UniBus 8 Zone Input Expander PCB
& Accessories (Includes 270mm UniBus
patch cable)



996515PCB&K
Integrati UniBus 8 Relay Auxiliary Expander
PCB & Accessories (Includes 270mm UniBus
patch cable)



996520PCB&K
Integrati UniBus 2 Port RS-232/RS-485
UART PCB & Accessories (Includes 270mm
UniBus patch cable)



Spare UniBus patch cables
996791SS - UniBus Patch Cable 150mm
996791S - UniBus Patch Cable 220mm
996791L - UniBus Patch Cable 270mm
996791LL - UniBus Patch Cable 475mm
996791XL - UniBus Patch Cable 675mm

The Integrati Access Controller (IAC) is a state-of-the-art IP connected intelligent Controller designed for Access Control applications. The IAC can directly manage up to 8 doors locally or up to 250 doors via RS-485 Sub-LAN expansion. All decision making is intelligently processed by the Controller with no reliance on the system server (should the connection to the server be offline). The result is a solution that is incredibly quick, robust and highly intelligent. The main Controller is equipped with connections for 2 Doors and 4 Wiegand Card Readers, a Watchdog Output, Ethernet and USB ports and a dedicated RS-485 reader port. Additional connections for Doors and Wiegand Readers can be added via the IAC's UniBus port with up to 3 UniBus 2 Door/2 Reader expansion devices (Part. 996535PCB&K), this allows for flexible configurations of 2, 4, 6 or 8 doors, and up to 10 Wiegand readers. The RS-485 Reader port accommodates up to 16 Inner Range SIFER or compatible third party OSDP multi-drop readers, providing 'in & out' directional access control for each door. The IAC can also be used for integration of wireless door locking systems from Assa Abloy Aperio, SimonsVoss or Salto Sallis. *Please see our website for Wireless Locking system Integration Guides for more details.*

Larger systems may consist of many IAC's networked together to form an enterprise-wide IP connected intelligent access control solution. Each IAC can support up to 3,000 Zone Inputs, 3,000 Outputs, 250 Areas and over 1,000 Card Readers and 250 Doors. User capacity of up to 100,000 users is available, and capacity for 1,000,000 users is also available with the User expansion kit. (Part. 996002L5)

Main Controller Features

- 2 Door Interfaces (Lock Relays) expandable to 8 via UniBus
- Reader Port – Encrypted RS-485, Up to 16 SIFER Readers
- Reader Port – RS-485/OSDP, Up to 16 compatible OSDP Readers
- Wiegand Reader ports – 4, expandable to 10 via UniBus
- Aperio, SimonsVoss, Salto Sallis integration - up to 8 Doors via RS-485 Reader port
- 2 DOTL Relay Outputs, expandable to 8 via UniBus
- RJ45 - 10/100 Ethernet Port
- SkyTunnel/Multipath-IP Alarm reporting (via RS-232 STU device)
- Peer-to-Peer Dialler Alarm Reporting (via an ISC Controller)
- Advanced Peer-to-Peer Mode
- RS-485 Sub-LAN
- USB Master & Slave Ports
- UniBus In-Cabinet Expansion Interface
- Dedicated Watch Dog Output
- Dedicated Tamper Input
- 32 Bit ARM CPU, 64 MB RAM, 4 GB Micro SD Memory
- Firmware Upgrade via USB or Software
- Choice of 3Amp or 8Amp Power Supply and enclosure options
- Built-in module locater buzzer



ABOVE:
IAC shown in 8 Door / 10 Reader configuration. (IAC with UniBus 2 Door / 2 Reader expansion devices connected). Housed in the WideBody enclosure with hinge plate, 8Amp PSU, Fire Door override relay card and 2x 17Ah batteries

| UniBus Device Compatibility Guide | UniBus Host Module | | | |
|-----------------------------------|--------------------|-----|-----------------|------|
| | ISC | IAC | 8 Zone Expander | ILAM |
| 8 Zone Expander | 2 | 0 | 3 | 0 |
| 2 Relay Expander* | 4 | 2 | 4 | 2 |
| 2 Door / 2 Reader Expander | 0 | 3 | 0 | 3 |
| 16 Floor Lift Interface | 6 | 6 | 6 | 6 |
| RS-232/RS-485 UART | 4 | 4 | 0 | 0 |
| Analogue Expander | 4 | 0 | 6 | 0 |

*Relays can be used for general purpose outputs when mapped to Aux 1~16 on IAC, and cannot be mapped to Aux 17~32

Connectivity

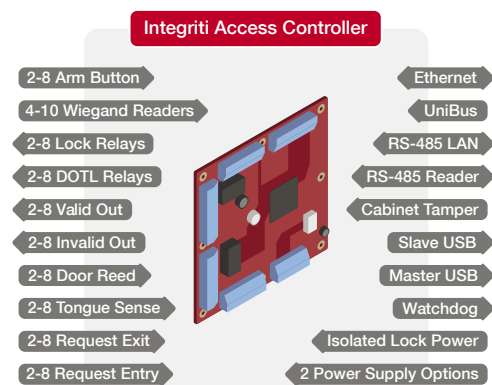

Integrati Access Controller Architecture

The IAC directly supports configurations for 2, 4, 6 or 8 doors with up to 16 SIFER or OSDP Readers for both in and out access control on all doors

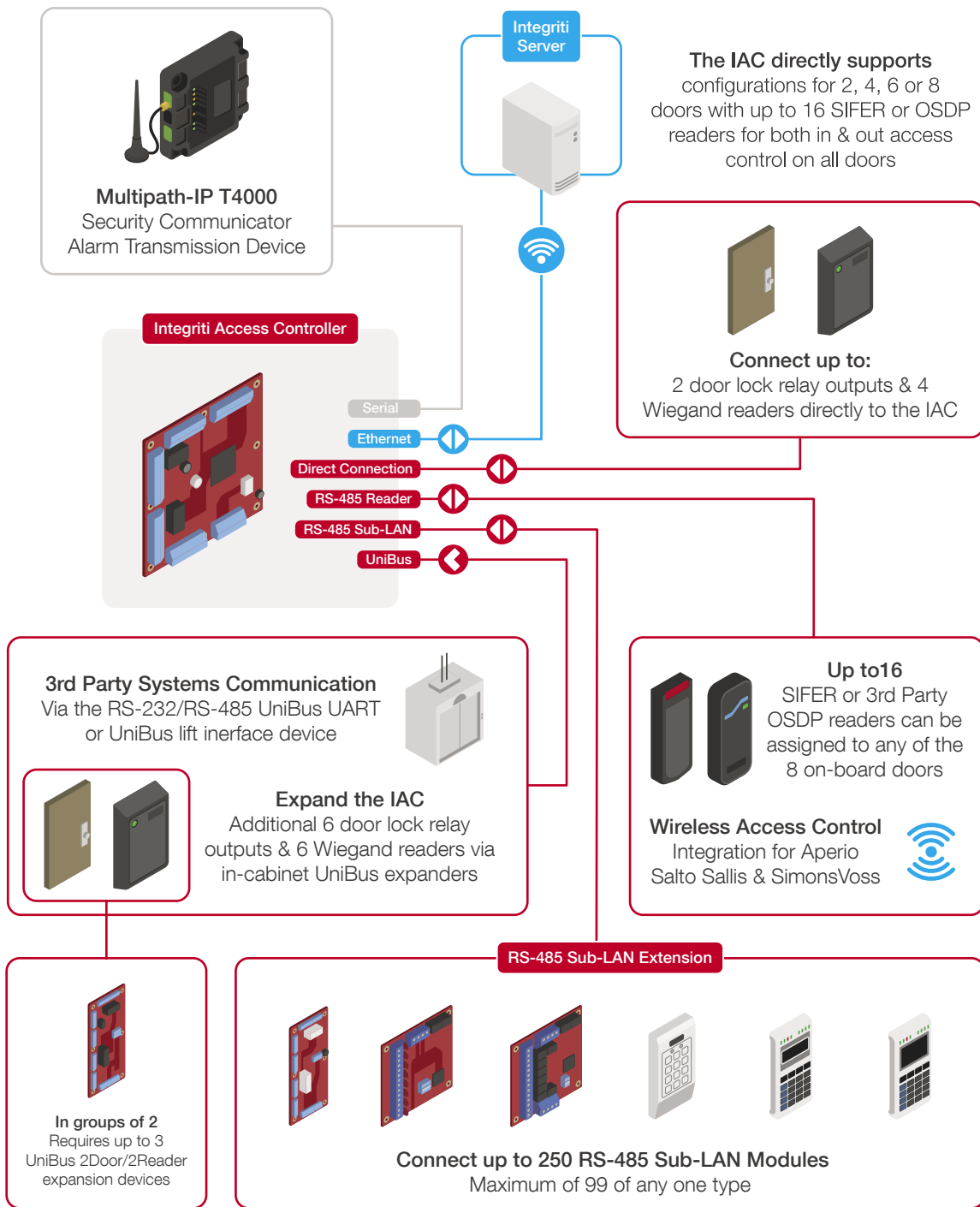

Specifications

Physical

| | |
|---------------------------|---|
| Enclosure Dimensions: | Medium - 460(L) x 358(W) x 85(D) (mm): Part# 995201PE3 or 995201PE8 - houses 1 x 996035+ 1 x 996535* |
| | XLarge - 702(L) x 358(W) x 85(D) (mm): Part# 995203PE3 or 995203PE8 - houses 1 x 996035 + up to 3 x 996535* |
| | WideBody - 580(L) x 510(W) x 95(D) (mm): Part# 995204PE3 or 995204PE8 - houses 1 x 996035 + up to 3 x 996535* |
| | Rack Mount - 2RU 680(L) x 420(W) x 85(D) (mm): Part# 995220PE3 or 995220PE8 - houses 1 x 996035 + up to 2 x 996535* |
| PCB Size Code: | Integriti "A" size |
| PCB Dimensions: | 200(L) x 200(W) x 45(D) (mm) |
| Shipping Weight : | 700grams (Circuit board & Accessories only) |
| Installation Environment: | 0°C - 70°C @15% - 90% Relative humidity (non-condensing) |

Electrical (For PCB Only)

| | |
|---|--|
| Power Supply Input: | 11V to 14VDC (from external Integriti 3Amp or 8Amp SMART PSU) |
| Current Consumption: | 150mA standby, 220mA with on-board lock relays on, add 15mA for each active DOTL relay |
| NOTE: Current consumption does not include the current required by readers or other external devices such as locks, buzzers, lamps or any device attached to the DOTL, Valid, Invalid, RS-485 Reader and UniBus connections | |
| Reader Head Supply O/P: | 5V/13.8V DC, 300mA maximum per reader, 1Amp max for all readers |
| Over Current Protection: | Reader +V connections. Protected with self-resetting PTCs |
| Typical Reader Current: | Allow 50~120mA for small Proximity Readers, 120~180mA for standard Proximity Readers (See reader datasheets for specific detail) |
| RS-485 Reader LAN Current: | Allow 75~150mA per SIFER reader connected |

Contact Ratings

| | |
|--------------|---|
| Lock Relays: | 5 Amps @ 30VDC |
| DOTL Relays: | 1 Amp @ 30VDC (Door Open Too Long output) |

Connections

| | |
|---------------------------|---|
| Ethernet: | 10/100 Ethernet Port |
| USB Host: | USB type "A" connection |
| USB Slave: | USB type "B" connection |
| Port Zero: | 5 Pin header for PC or Multipath-IP STU connection |
| Smart Card Slot: | For use with Smart Card (System Options Card) |
| Lock 1 & 2: | Includes Lock+, Lock-, NO/COM/NC |
| Door 1 & 2: | Includes Reed, 2 x 0v, Tongue, REN, REX, DOTL contacts |
| Wiegand Reader Ports x 4: | Includes Valid, Invalid, 0V, Reader+, D1, D0, ARM |
| Lock Power Input: | Includes Lock+, Lock- connections from external PSU |
| Cabinet Tamper: | 2 pin connection for cabinet tamper switch |
| Watchdog Output: | 2 pin connection for remote monitoring system |
| UniBus Port: | 1 x UniBus Host expansion port for up to 6 local UniBus devices |
| RS-485 LAN: | 1, Includes LAN+, LAN-, A, B. (LAN addressing set via DIP switches) |
| RS-485 Reader: | 1 Includes LAN+, LAN-, A, B, Auto addressing for SIFER Readers |
| External Power: | 10way header block for connection to Integriti power supplies |

External Power Supply Monitoring (Compatible with IR SMART Power Supplies)

| | |
|----------------|---------------------------|
| AC Fail: | External PS AC Fail |
| Low Battery: | External PS Low Battery |
| LAN Fuse: | External PS LAN Fuse |
| Detector Fuse: | External PS Detector Fuse |
| Low Volts: | External PS Low Volts |
| PSU Fail: | External PS Fail |

Compliance

| | |
|---------------|--|
| Electrical | |
| Environmental | |

* Additional external power may be required for 3Amp models.

Ordering Options



Integrati IAC Controllers
996035PCB&K
Integrati IAC Controller PCB



UniBus Door Expander
996535PCB&K
Integrati UniBus 2 Door Expander PCB & Accessories
(Includes 270mm UniBus patch cable)



IAC Controller shown in 8 Door configuration. Housed in a WideBody Enclosure with 8Amp SMART Power Supply & 3 x UniBus Door Expanders. (IK-996035WB8PS Kit)

The optional Fire door emergency release relay card is also shown. (Part 995916)

The IAC Controller is available from Inner Range distributors in kit form (These are kitted by the distributor)

- IK-996035M2PS Integrati IAC 2 Door Kit Medium Enclosure with 3Amp SMART PSU
- IK-996035WB4PS Integrati IAC 4 Door Kit WideBody Enclosure with 8Amp SMART PSU
- IK-996035WB6PS Integrati IAC 6 Door Kit WideBody Enclosure with 8Amp SMART PSU
- IK-996035WB8PS Integrati IAC 8 Door Kit WideBody Enclosure with 8Amp SMART PSU



995201PE3

Enclosures to Suit IAC

Medium - 995201PE8 with 8Amp SMART PSU
Houses 1 x 996035PCB&K & 1 x 996535PCB&K

Medium - 995201PE3 with 3Amp SMART PSU
Houses 1 x 996035PCB&K & 1 x 996535PCB&K*

Medium - 995201 empty enclosure only



995203PE8

XLarge - 995203PE8 with 8Amp SMART PSU
Houses 1 x 996035PCB&K & up to 3 x 996535PCB&K

XLarge - 995203PE3 with 3Amp SMART PSU
Houses 1 x 996035PCB&K & up to 3 x 996535PCB&K*

XLarge - 995203 empty enclosure only



995204PE8

WideBody - 995204PE8 with 8Amp SMART PSU
Houses 1 x 996035PCB&K & up to 3 x 996535PCB&K

WideBody - 995204PE3 with 3Amp SMART PSU
Houses 1 x 996035PCB&K & up to 3 x 996535PCB&K*

WideBody - 995204 empty enclosure only

WideBody - 999027 hinged expansion plate kit to suit 995204



995220PE3

Rack Mount - 995220PE8 2RU drawer with 8Amp SMART PSU
Houses 1 x 996035PCB&K & up to 2 x 996535PCB&K

Rack Mount - 995220PE3 2RU drawer with 3Amp SMART PSU
Houses 1 x 996035PCB&K & up to 2 x 996535PCB&K*

Rack Mount - 995220 empty enclosure only

* Additional external power may be required for enclosures with 3Amp PSU



996092



996091PCB&K

Power Supplies to suit IAC

996092 8Amp 13.75VDC SMART Power Supply Module, PSU only

996091PCB&K 3Amp 13.75VDC SMART Power Supply PCB & accessories

The Integrati Intelligent LAN Access Module (ILAM) can be used to control and monitor up to 8 Doors or Lift cars on the Integrati RS-485 LAN, or via IP LAN if connected using Ethernet Bridge or CLOE devices. The base module supports 2 doors/2 readers and is expandable up to 8 doors/8 readers with the simple addition of 2 Door expander boards via the UniBus in-cabinet expansion interface.

The Integrati Intelligent LAN Access Module offers a complete suite of programmable options to provide advanced high-security access control, security area control and door alarm monitoring functions. Offline intelligence is also provided via the on-board database to provide access control functionality and event logging even if communications to the master controller are severed. Upon re-connection, all buffered events and any programming changes are automatically synchronised with the master Controller (ISC/IAC).

The ILAM is also used for integration of wireless door locking systems from Assa Abloy Aperio, SimonsVoss or Salto Sallis. Please see our website for Wireless Locking system Integration Guides for more details.

The power supply requirement is 11 to 14VDC and a range of Integrati plug on external 2Amp, 3Amp or 8Amp Switch Mode power supplies are available. The SMART 3Amp & 8Amp models are fully monitored via the Intelligent LAN Access Module.



ABOVE:

ILAM shown in 4 Door / 4 Reader configuration. (ILAM with UniBus 2 Door / 2 Reader expansion device connected) Housed in the Medium size 995201PE3 enclosure with 3Amp SMART Power Supply.

Integrati Intelligent LAN Access Module with UniBus In-Cabinet Expansion

- Up to 8 Doors
- Up to 8 Wiegand readers or 16 SIFER RS-485 Readers
- Up to 8 Lift cars

Features

- RS-485 LAN connectivity
- RS-485 Reader connectivity (up to 16 SIFER or third party OSDP Readers)
- Reader options to control Doors, Lifts, Areas and User Logon
- Supports Wiegand card readers up to 88bits
- Reader outputs with individual self-resetting overcurrent protection
- UniBus in-cabinet expansion interface
- Dedicated lock power input
- External Integrati power supply connection
- Full monitoring of external Integrati power supply
- Heavy duty lock relays
- Reader Valid & Invalid outputs
- Door reed & tongue sense inputs per door
- Door request to enter & exit inputs per door
- DOTL relay outputs per door
- Dedicated cabinet tamper input
- Small PCB size 200 x 95mm
- Over-The-Wire firmware upgradable
- Built-in module locater buzzer

Doors, Expansion & Integration Options

- Expandable to 8 Doors (2 Doors on-board)
- Expandable to 16 Inner Range SIFER or third party OSDP RS-485 readers via the dedicated RS-485 reader port
- Expandable to 8 Wiegand Readers (2 Readers on-board)
- Five enclosure sizes allow 2, 4, 6 or 8 Door/Reader configurations
- Three plug on external power supply options (2A, SMART 3A or SMART 8A Switch Mode)
- Aperio, SimonsVoss, Salto Sallis integration - up to 8 Doors via RS-485 Reader port
- Lift button I/O interfacing via optional UniBus Lift interface card (Up to 96 Floors)

Offline Intelligence

- Offline intelligence provided for all Wiegand readers and standard lock outputs
- Offline Access Control database for 100,000 users
- Offline time periods
- Offline event database of 100,000 events

| UniBus Device Compatibility Guide | UniBus Host Module | | | |
|-----------------------------------|--------------------|-----|-----------------|------|
| | ISC | IAC | 8 Zone Expander | ILAM |
| 8 Zone Expander | 2 | 0 | 3 | 0 |
| 8 Relay Expander | 4 | 2 | 4 | 2 |
| 2 Door / 2 Reader Expander | 0 | 3 | 0 | 3 |
| 16 Floor Lift Interface | 6 | 6 | 6 | 6 |
| RS-232/RS-485 UART | 4 | 4 | 0 | 0 |
| Analogue Expander | 4 | 0 | 6 | 0 |

Connectivity

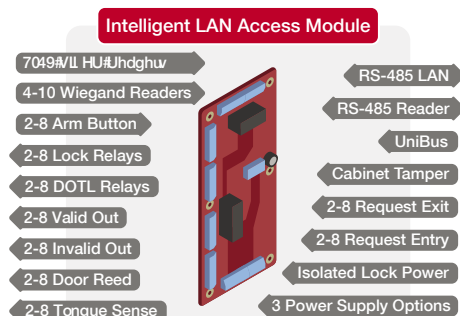

Specifications

Physical

| | |
|---------------------------|--|
| Enclosure Options: | Small - 252(L) x 358(W) x 85(D) (mm): Part# 995200PE2 or 995200PE3 - houses 1 x 996018* |
| | Medium - 460(L) x 358(W) x 85(D) (mm): Part# 995201PE2, 995201PE3 or 995201PE8 - houses 1 x 996018 + up to 2 x 996535* |
| | XLarge - 702(L) x 358(W) x 85(D) (mm): Part# 995203PE2, 995203PE3 or 995203PE8 - houses 1 x 996018 + up to 3 x 996535* |
| | WideBody - 580(L) x 510(W) x 95(D) (mm): Part# 995204PE3 or 995204PE8 - houses 1 x 996018 + up to 3 x 996535* |
| | Rack Mount - 2RU 680(L) x 420(W) x 85(D) (mm): Part# 995220PE2, 995220PE3 or 995220PE8 - houses 1 x 996018 + up to 3 x 996535* |
| PCB Size Code: | Integriti "B" size |
| PCB Dimensions: | 200(L) x 94(W) x 45(D) (mm) |
| Shipping Weight: | 270grams. (Circuit board & Accessories only) |
| Installation Environment: | 0°C - 70°C @15% - 90% Relative humidity (non-condensing) |

Electrical (For PCB Only)

| | |
|--|--|
| Power Supply Input: | 11V to 14VDC |
| Current Consumption: | 110mA standby. 175mA with lock relays on |
| <i>NOTE: Current consumption does not include the current required by readers or other external devices such as locks, buzzers, lamps or any device attached to the DOTL, Valid, Invalid, RS-485 Reader and UniBus connections</i> | |
| Over Current Protection: | Reader +V connections. Protected with self-resetting PTC's |

Contact Ratings

| | |
|--------------|---|
| Lock Relays: | 5 Amps @ 30VDC |
| DOTL Relays: | 1 Amp @ 30VDC (Door Open Too Long output) |

Connections

| | |
|-----------------------|---|
| Lock 1 & 2: | Includes Lock+, Lock-, NO/COM/NC |
| Door 1 & 2: | Includes Reed, 2 x 0v, Tongue, REN, REX, DOTL contacts |
| Wiegand Reader 1 & 2: | Includes Valid, Invalid, 0V, Reader+, D1, D0, ARM |
| Lock Power: | Includes Lock+, Lock- connections from external PSU |
| Cabinet Tamper: | 2 pin connection for cabinet tamper switch |
| UniBus Port: | 1 x UniBus Host expansion port |
| RS-485 LAN: | 1, Includes LAN+, LAN-, A, B. (LAN addressing set via DIP switches) |
| RS-485 Reader: | 1, Supports up to 16 Inner Range SIFER or compatible OSDP readers, or 1 Salto Sallis, Aperio or SimonsVoss wireless access control hub) |

External Power Supply Monitoring (Compatible with IR SMART PSU Devices)

| | |
|----------------|---------------------------|
| AC Fail: | External PS AC Fail |
| Low Battery: | External PS Low Battery |
| LAN Fuse: | External PS LAN Fuse |
| Detector Fuse: | External PS Detector Fuse |
| Low Volts: | External PS Low Volts |
| PSU Fail: | External PS Fail |

Compliance

| | |
|---------------|--|
| Electrical | |
| Environmental | |

*Additional external power is required for 6 and 8 door configurations.

Ordering Options



Intelligent LAN Access Module PCB & Kit
996018PCB&K

Intelligent LAN Access Module PCB & Kit
with 2 Doors & 2 Readers on-board



UniBus 2 Door / 2 Reader Expansion Board
996535PCB&K

UniBus 2 Door / 2 Reader expansion-board PCB & Kit

Reader Options



Inner Range SIFER Smart Card Reader
994720

RS-485 multi-drop 128 bit AES encrypted
DESFire® EV1/EV2 reader.

994720MF
SIFER Smart Card Reader - As above +
Multi-Format enabled to read the Card Serial
Number of 3rd party cards

994725
SIFER Keypad/Reader

994725MF
SIFER Keypad/Reader Multi-Format enabled

Enclosure Options



995200PE3
small
enclosure
shown

Enclosures
Small

995200PE2 - 2Amp PSU*
995200PE3 - 3Amp SMART PSU*

Medium
995201PE2 - 2Amp PSU*
995201PE3 - 3Amp SMART PSU*
995201PE8 - 8Amp SMART PSU

XLarge
995203PE2 - 2Amp PSU*
995203PE3 - 3Amp SMART PSU*
995203PE8 - 8Amp SMART PSU

Please see enclosure section or website for further details on enclosures.

* Additional external power may be required for 2 and 3Amp models.

*** Suitable for 995203 series enclosures only

Spare Mounting Plates for Medium, Large and WideBody Enclosures

- 999026 - Medium mounting plate to suit Integriti PCB's
- 999006 - Large mounting plate to suit Concept or Integriti PCB's***
- 999027 - 2nd tier hinged expansion plate to suit WideBody enclosure

WideBody

- 995204PE3 - 3Amp SMART PSU*
- 995204PE8 - 8Amp SMART PSU
- Rack Mount Drawer**
- 995220PE2 2RU - 2Amp PSU*
- 995220PE3 2RU - 3Amp SMART PSU*
- 995220PE8 2RU - 8Amp SMART PSU

The Integriti Standard LAN Access Module (SLAM) can be used to control and monitor up to 2 doors on the Integriti RS-485 LAN, or via IP LAN if connected using Ethernet Bridge or CLOE devices.

The module supports 2 doors and up to 4 Inner Range RS-485 SIFER or third party OSDP readers to accommodate entry and exit readers on both doors. Alternatively, 2 Wiegand readers may be connected to allow control and monitoring of a single door with entry and exit readers or 2 doors with a single reader each.

The SLAM offers a complete suite of programmable options to provide advanced high-security access control, security area control and door alarm monitoring functions. Cached functionality is also provided via the on-board database to provide offline access control operation for up to 2,000 user cards if communications to the master Controller (ISC/IAC) are lost. Cache expiry time for the module can be configured with expiry times ranging from 1 hour to 4 months. In addition, each user has an option to be stored permanently within the modules cache, particularly useful for situations where certain staff may need to be guaranteed access if the module is offline.

The SLAM is also used for integration of wireless door locking systems from Assa Abloy Aperio, SimonsVoss or Salto Sallis. Please see our website for Wireless Locking system Integration Guides for more details.

The power supply requirement is 11 to 14VDC and a range of Integriti plug on external 2Amp, 3Amp or 8Amp Switch Mode power supplies are available. The SMART 3Amp & 8Amp models are fully monitored via the Standard LAN Access Module.

Heavy duty relays are provided for lock switching, along with auxiliary outputs for "Valid", "Invalid" and "Door Open Too Long Warning" to control LEDs and/or buzzers.

Programming options allow for each Reader to be configured independently and security area control to be integrated with access control where required. Door Contacts and/or Tongue Sense inputs are utilized to provide "Door Forced" and "Door Open Too Long" alarms. Any spare zones may be used as general purpose zone inputs for use with PIR's, PE Beams, etc.

Features

- Offline 2,000 user card cache
- RS-485 Reader connectivity (up to 4 SIFER or compatible OSDP Readers)
- Entry and exit readers for both doors when using Inner Range SIFER or third party OSDP readers
- Reader options to control Doors, Lifts, Areas and Keypad User Logon
- Supports Wiegand card readers up to 88bits
- Wiegand reader outputs with individual self-resetting overcurrent protection
- Aperio, SimonsVoss, Salto Sallis integration - up to 2 Doors via RS-485 Reader port
- Dedicated lock power input
- External Integriti power supply connection
- Full monitoring of external Integriti SMART power supply
- Heavy duty lock relays
- Reader Valid & Invalid outputs
- Door reed & tongue sense inputs per door
- Door request to enter & exit inputs per door
- DOTL relay outputs per door
- Dedicated cabinet tamper input
- RS-485 LAN connectivity
- Over-The-Wire firmware upgradeable
- Small PCB size 200 x 95mm
- Built-in module locator buzzer

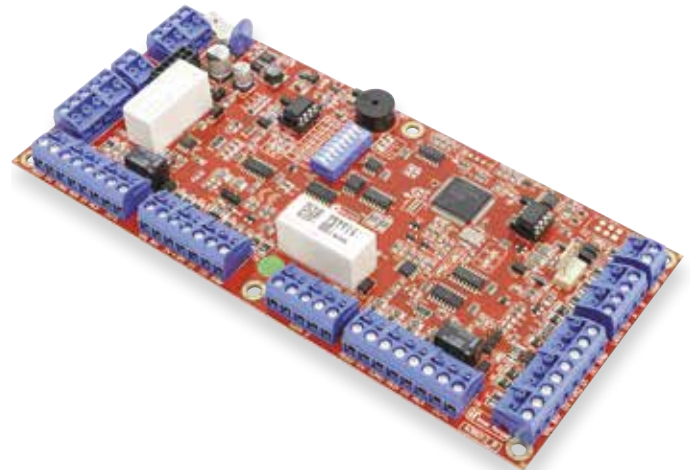

Offline Cache Features

- Offline cache provided for 2,000 user cards
- Oldest card is overwritten by newest card when cache is full
- Configurable cache expiry times
- User cards can be made permanent in cache
- REX & REN buttons are also cached

Connectivity

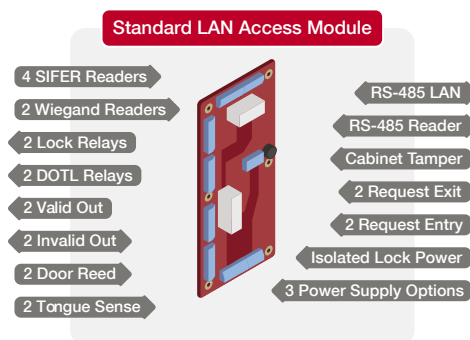

Specifications

Physical

| | |
|---------------------------|---|
| Enclosure Options: | Small - 252(L) x 358(W) x 85(D) (mm): Part# 995200PE2 or 995200PE3 - houses 1 x 996012* |
| | Medium - 460(L) x 358(W) x 85(D) (mm): Part# 995201PE2, 995201PE3 or 995201PE8 - houses up to 3 x 996012* |
| | XLarge - 702(L) x 358(W) x 85(D) (mm): Part# 995203PE2, 995203PE3 or 995203PE8 - houses up to 5 x 996012* |
| | WideBody - 580(L) x 510(W) x 95(D) (mm): Part# 995204PE3 or 995204PE8 - houses up to 6 x 996012* |
| | Rack Mount - 2RU 680(L) x 420(W) x 85(D) (mm): Part# 995220PE2, 995220PE3 or 995220PE8 - houses up to 4 x 996012* |
| PCB Size Code: | Integriti "B" size |
| PCB Dimensions: | 200(L) x 94(W) x 45(D) (mm) |
| Shipping Weight: | 306grams (Circuit board and Accessories only) |
| Installation Environment: | 0°C - 70°C @15% - 90% Relative humidity (non-condensing) |

Electrical (For PCB Only)

| | |
|--|--|
| Power Supply Input: | 11V to 14VDC |
| Current Consumption: | 110mA standby, 175mA with lock relays on |
| <i>NOTE: Current consumption does not include the current required by readers or other external devices such as locks, buzzers, lamps or any device attached to the DOTL, Valid, Invalid and RS-485 Reader connections</i> | |
| Over Current Protection: | Reader +V connections. Protected with self-resetting PTC's |

Contact Ratings

| | |
|--------------|---|
| Lock Relays: | 5 Amps @ 30VDC |
| DOTL Relays: | 1 Amp @ 30VDC (Door Open Too Long output) |

Connections

| | |
|-----------------------|---|
| Lock 1 & 2: | Includes Lock+, Lock-, NO/COM/NC |
| Door 1 & 2: | Includes Reed, 2 x 0v, Tongue, REN, REX, DOTL contacts |
| Wiegand Reader 1 & 2: | Includes Valid, Invalid, OV, Reader+, D1, D0, ARM |
| Lock Power: | Includes Lock+, Lock- connections from external PSU |
| Cabinet Tamper: | 2 pin connection for cabinet tamper switch |
| RS-485 LAN: | 1, Includes LAN+, LAN-, A, B. (LAN addressing set via DIP switches) |
| RS-485 Reader Port: | 1, Supports up to 4 Inner Range SIFER or compatible OSDP readers, or 1 Salto Sallis, Aperio or SimonsVoss wireless access control hub |

External Power Supply Monitoring (Compatible with Inner Range 3 & 8Amp SMART PSU's)

| | |
|----------------|---------------------------|
| AC Fail: | External PS AC Fail |
| Low Battery: | External PS Low Battery |
| LAN Fuse: | External PS LAN Fuse |
| Detector Fuse: | External PS Detector Fuse |
| Low Volts: | External PS Low Volts |
| PSU Fail: | External PS Fail |

Compliance

Electrical



Environmental



* Additional external power may be required.

Ordering Options

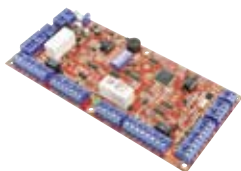

Standard LAN Access Module (SLAM)
996012PCB&K
 Standard LAN Access Module PCB & Kit

Reader Options



Inner Range SIFER Smart Card Reader
994720
 RS-485 multi-drop 128 bit AES encrypted DESFire® EV1/EV2 reader.
994720MF
 SIFER Smart Card Reader - As above + Multi-Format enabled to read the Card Serial Number of 3rd party cards
994725
 SIFER Keypad/Reader
994725MF
 SIFER Keypad/Reader Multi-Format enabled

Enclosure Options



995200PE3 small enclosure shown

Enclosures Small
 995200PE2 - 2Amp PSU*
 995200PE3 - 3Amp SMART PSU*
Medium
 995201PE2 - 2Amp PSU*
 995201PE3 - 3Amp SMART PSU*
 995201PE8 - 8Amp SMART PSU
XLarge
 995203PE2 - 2Amp PSU*
 995203PE3 - 3Amp SMART PSU*
 995203PE8 - 8Amp SMART PSU

Spare Mounting Plates for Medium, Large and WideBody Enclosures

999026 - Medium mounting plate to suit Integriti PCB's
999023 - Medium mounting plate to suit Concept PCB's
999006 - Large mounting plate to suit Concept or Integriti PCB's***
999027 - 2nd tier hinged expansion plate to suit WideBody enclosure

WideBody
 995204PE3 - 3Amp SMART PSU*
 995204PE8 - 8Amp SMART PSU
Rack Mount Drawer
 995220PE2 2RU - 2Amp PSU*
 995220PE3 2RU - 3Amp SMART PSU*
 995220PE8 2RU - 8Amp SMART PSU

Please see enclosure section or website for further details on enclosures.
 * Additional external power may be required for 2 and 3Amp models.
 *** Suitable for 995203 series enclosures only

SIFER READER

The SIFER card reader is a Smart Card reader designed and manufactured by Inner Range. It is a multi-drop RS-485 based reader that employs 128 bit AES encryption from the card through to the door module, providing a far superior level of security than that of traditional Wiegand based card readers. SIFER readers utilise the Mifare DESFire© EV1/EV2 card format.

As SIFER readers utilise a superset of the OSDP protocol, the readers may also be deployed on any system capable of using OSDP. SIFER readers are connected to the RS-485 reader port for full Reader-In and Reader-Out operation of various Inner Range products as below.

- Integriti Access Controller (IAC) - Up to 16 Readers
- Integriti Intelligent LAN Access Module (ILAM) - Up to 16 Readers
- Integriti Standard LAN Access Module (SLAM) - Up to 4 Readers

SIFER readers are IP67 rated and available with site-specific encryption keys.

Four card ordering options are available:

1. **SIFER-P:** Pre-programmed 'stock' cards with card number printed. The most cost-effective option but card customisation is not supported. With more than four billion card numbers available each SIFER-P card is guaranteed to be unique.
2. **SIFER-U:** User Programmable cards that allow an installer to customise the card number, site code and use their own encryption key. Printed with factory card number.
3. **SIFER-C:** Custom batch orders configured by the factory according to the specified card number range, site code, encryption key and printing options. Cards cannot be re-programmed at a later stage by the installer or the factory.
4. **ECOLITE:** ECOLITE is a budget range of credentials that is compatible with Inner Range SIFER Readers, Integriti & Inception systems. These credentials are based on the MIFARE Ultralight EV1 technology which is a lower priced - lower security option compared to the standard DESFire EV1/EV2 technology used in our SIFER-P, SIFER-U & SIFER-C range of credentials.

Features

- Secure 128bit AES Encryption
- Encrypted from Card Through to Access Module
- Mifare DESFire© EV1/EV2 Card Format
- Water & Dust Resistant to IP67
- Vandal Resistant (fully potted)
- Flexible LED Colour & Function Assignment
- Audible Buzzer (can use as DOTL)
- Multi-drop RS-485 Reader LAN
- Individual Reader Heartbeat Monitoring
- Integriti Auto Reader Discovery
- OSDP Compatible
- Read Card Serial Number (CSN) From 3rd Party Cards (Multi-Format Version Only)
- Support for Custom Site Codes and Site Specific Encryption
- User Programmable Cards Offer Great Flexibility For Installers
- Global Configuration From Integriti Systems (including firmware updates)
- Small Footprint (Dimensions: 39 (W) x 93 (H) x 15 (D) mm)



Multi-Format Version

The SIFER Multi Format Card reader offers an identical set of features to the Standard SIFER Reader with additional support for reading the CSN of third party 13.56Mhz credentials.

| SIFER Connectivity Guide | SIFER Host Module | | |
|--------------------------|-------------------|------|------|
| | IAC | SLAM | ILAM |
| SIFER Reader Qty | 16 | 4 | 16 |



A plug-on SIFER Reader board is available for EliteX & PrismaX Keypads. When fitted, SIFER access cards can be presented at the Keypads for card & PIN login or for access control on a local door.

Specifications

Physical

| | |
|---------------------------|---|
| Reader Size: | 93(L) x 39(W) x 15(D) (mm) |
| Shipping Weight: | 108grams (Reader & Accessories) |
| Mounting Plate: | 91.5(L) x 38(W) (mm) |
| Mounting Method: | 2 x fixing screws for mounting plate |
| Mounting Holes: | 65.5mm hole spacing |
| Mounting Surface: | Optimised for flat non-metallic surfaces |
| Cavity Cable Entry Hole: | Up to 20mm |
| Installation Environment: | -35°C to 65°C @15% - 90% relative humidity (non-condensing) |
| Ingress Protection: | IP67 |

Reader Protocols

| | |
|------------------------|--|
| Device Communications: | Open Supervised Device Protocol (OSDP) |
| Operating Frequency: | 13.56 Mhz |
| Credentials: | Mifare DESFire® EV1/EV2 with AES encryption |
| Credentials: | Read Card Serial Number (CSN) from 3rd party cards (MF Model Only) |

Connections

| | |
|------------------------------------|---|
| Pigtail Cable Length: | 500mm |
| Pigtail Extension Cable Type: | 2-pair 7/0.20 twisted pair data cable as minimum. 2-pair 14/0.20 multi-strand shielded twisted pair data cable is preferred (e.g. Belden 8723). See installation manual for more info. |
| Connection Methods: | RS-485 multi-drop star or daisy chain configurations |
| Total Overall Cable Length: | 1000 meters total on one RS-485 reader port guaranteed |
| Max Readers: | Up to 16 with IAC & ILAM, Up to 4 with SLAM |
| Compatible Integriti Host Modules: | Standard LAN Access Module (SLAM), Intelligent LAN Access Module (ILAM), Integriti Access Controller (IAC) |

Reader Security

| | |
|--------------------------|---|
| Physical Tamper: | Optical beam to mounting surface |
| Card to Reader: | 128bit AES encryption |
| Reader to Access Module: | 128bit AES encryption |
| Vandal Resistance: | Fully encapsulated vandal resistant electronics |

Reader Configuration

| | |
|-------------------------|--|
| LAN Addressing: | Fully automatic when used with Integriti systems Manual addressing with 3rd party OSDP compatible systems |
| Firmware Updates: | Over-the-wire firmware updates when used with Inner Range systems |
| Reader Purpose Options: | Control a Door, Control a Lift, Log on, Area status toggle |

LED & Beeper Indicators

| | |
|---------------------------|---|
| LED Configuration: | Brightness, Colours & Feedback modes - configurable via Integriti Software |
| LED 1 & 2 Colour Options: | RGB Indicator 23 colour selectable |
| Feedback Modes for LED's: | Area Status, Area Alarm/Isolated, Entry/Exit Delay, Door open/locked status, Valid/Invalid card badge, No LED's |
| Beeper Volume: | Variable - configurable via Integriti software |
| Beeper Feedback Options: | Valid/Invalid card badge, Door Open tool long (DOTL), Area Alarm, Entry/Exit Delay |

Power Requirements

| | |
|----------------------|--|
| Input: | 11-14V DC <500mV ripple |
| Current Consumption: | 75-100mA typical, 150mA MAX with all LED's driven at full brightness |

Compliance

| | |
|----------------|--|
| Electrical: | |
| Environmental: | |

**SIFER-C cards are programmed with a custom encryption key and will require at least one SIFER Reader Configuration card with the initial batch. The SIFER Reader Configuration Card is available under Part Number 994614CNF

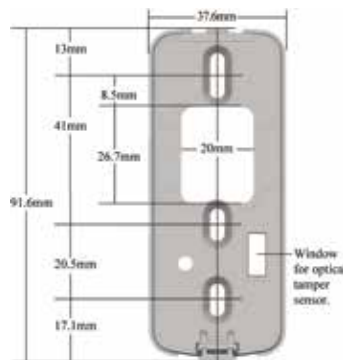

Ordering Options



Readers

- 994720**
SIFER Smart Card Reader
- 994720MF**
SIFER Smart Card Reader - Multi Format Version



Credentials

- ISO Cards**
- 994610**
SIFER-P DESFire® EV2 4K ISO (Pre-programmed - Printed)
- 994612**
SIFER-U DESFire® EV2 4K ISO (User Programmable - Printed)
- 994614****
SIFER-C DESFire® EV2 4K ISO (Custom Programmed - Printed)
- 994580**
ECOLITE MIFARE Ultralight EV1 (Pre-programmed)



Key FOB's

- 994616**
SIFER-P DESFire® EV2 4K FOB (Pre programmed - Printed)
- 994618**
SIFER-U DESFire® EV2 4K FOB (User Programmable - Printed)
- 994620****
SIFER-C DESFire® EV2 4K FOB (Custom Programmed - Printed)



Management Tools

- 994750** SIFER Card Programming Station
- 994751** SIFER Card Enrollment Station



Mounting Accessories

- 999033** 10mm Spacer (For mounting to metal)
- 999034** Vandal Resistant Cover - standard
- 999035** Vandal Resistant Cover - with inbuilt spacer

The SIFER reader spacer introduces a 10 mm offset between the reader and the installation surface which allows a SIFER reader to be installed on a metallic surface without degrading the read range.

The two mounting holes align with those on the SIFER reader mounting plate and the large cable entry cut-out allows the spacer to be fitted over a reader that is already installed without needing to disconnect and re-terminate the cable.

Compatible with SIFER Readers 994720 and 994720MF



Specifications

Physical

| | |
|-------------|-----------------------------------|
| Dimensions: | 97.1(h) x 40.7(w) x 10(d) (mm) |
| | SIFER Reader + Spacer Depth: 26mm |

Compatible Readers:

| |
|--|
| 994720 - IR SIFER Smart Card Reader |
| 994720MF - IR SIFER Multi Format Smart Card Reader |

Ordering Options

999033
SIFER Reader Spacer



The SIFER Reader Vandal Resistant Cover adds an extra layer of physical security to SIFER readers. The angled design helps withstand physical attack and prevent damage to the SIFER readers.

The SIFER Reader Vandal Resistance Cover is available with an inbuilt spacer which allows a SIFER reader to be installed on a metallic surface without degrading the read range.

Both versions of the cover are compatible with SIFER Readers 994720 and 994720MF

999034 SIFER Reader Vandal Resistant Cover

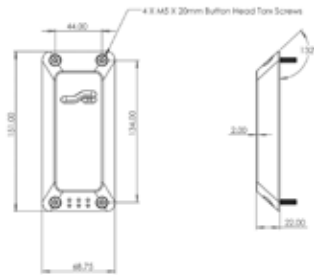

999035 SIFER Reader Vandal Resistant Cover with Inbuilt Spacer

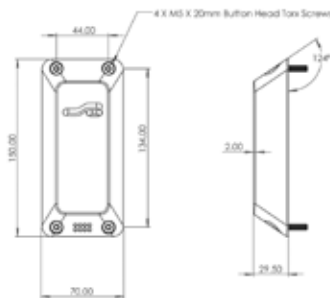

Specifications

Physical

| | |
|----------------------|--------------------------------|
| 999034 (Standard) | 151(h) x 68.75(h) x 22(d) (mm) |
| 999035 (With Spacer) | 150(h) x 70(w) x 29.5(d) (mm) |

Compatible Readers:

| |
|--|
| 994720 - IR SIFER Smart-Card Reader |
| 994720MF - IR SIFER Multi Format Smart-Card Reader |

Ordering Options

999034
SIFER Reader Vandal Resistant Cover

999035
SIFER Reader Vandal Resistant Cover with Inbuilt Spacer



SIFER KEYPAD

The SIFER Keypad is a combined IP67 rated Keypad and Smart Card reader that allows dual credential Card & PIN high security access control. (PIN only or Card only is also supported)

The SIFER Keypad is a multi-drop RS-485 device that employs 128 bit AES encryption from the card/keypad through to the door module, providing a far superior level of security than that of traditional Wiegand based keypads & card readers.

SIFER Keypads utilise the Mifare DESFire© EV1/EV2 card format. As SIFER Keypads utilise a superset of the OSDP protocol, the keypads may also be deployed on any system capable of using OSDP. SIFER Keypads are connected to the RS-485 reader port for full Reader-In and Reader-Out operation of various Inner Range products as below.

- Integrati Access Controller (IAC) - Up to 16 Keypads/Readers
- Integrati Intelligent LAN Access Module (ILAM) - Up to 16 Keypads/Readers
- Integrati Standard LAN Access Module (SLAM) - Up to 4 Keypads/Readers

SIFER Keypads are IP67 rated and available with site-specific encryption keys. Three card ordering options are available for use with the SIFER Keypad.

1. **SIFER-P:** Pre-programmed 'stock' cards with card number printed. The most cost-effective option but card customisation is not supported. With more than four billion card numbers available each SIFER-P card is guaranteed to be unique.
2. **SIFER-U:** User Programmable cards that allow an installer to customise the card number, site code and use their own encryption key. Printed with factory card number.
3. **SIFER-C:** Custom batch orders configured by the factory according to the specified card number range, site code, encryption key and printing options. Cards cannot be re-programmed at a later stage by the installer or the factory.
4. **ECOLITE:** ECOLITE is a budget range of credentials that is compatible with Inner Range SIFER Readers, Integrati & Inception systems. These credentials are based on the MIFARE Ultralight EV1 technology which is a lower priced - lower security option compared to the standard DESFire EV1/EV2 technology used in our SIFER-P, SIFER-U & SIFER-C range of credentials.

Features

- Secure 128bit AES Encryption
- Encrypted from Keypad/Card through to Access Module
- Supports Card&PIN, Card only or PIN only modes
- Auto dimming backlit Silicon rubber keypad
- Mifare DESFire© EV1/EV2 Card Format
- Water & Dust Resistant to IP67
- Vandal Resistant (fully potted)
- Flexible LED colour & function Assignment
- Audible Buzzer (can use as DOTL)
- Multi-drop RS-485 Reader LAN
- Individual Reader Heartbeat Monitoring
- Integrati Auto Reader Discovery
- OSDP Compatible



Multi-Format Version

A SIFER Multi-Format Keypad/Card reader is also available and offers an identical set of features to the Standard SIFER Keypad with additional support for reading the CSN of third party 13.56 Mhz credentials.

| SIFER Connectivity Guide | SIFER Host Module | | |
|--------------------------|-------------------|------|------|
| | IAC | SLAM | ILAM |
| SIFER Reader Qty | 16 | 4 | 16 |

- Read Card Serial Number (CSN) From 3rd Party Cards (Multi-Format Version Only)
- Support for Custom Site Codes and Site Specific Encryption
- User Programmable Cards Offer Great Flexibility for Installers
- Global Configuration From Integrati Systems (including firmware updates)
- Small Footprint (Dimensions: 64 (W) x 106(H) x 18 (D) mm)

A plug-on SIFER Reader board is available for EliteX & PrismaX Keypads. When fitted, SIFER access cards can be presented at the Keypads for card & PIN login or for access control on a local door.



Specifications

Physical

| | |
|-----------------------------|--|
| Reader Size: | 106(L) x 64(W) x 18(D) (mm) |
| Keypad Button Size: | 12.3 X 9 (MM) Auto-dimming back lit |
| Shipping Weight: | 162grams |
| Mounting Plate: | 102.7(L) x 60.2(W) (mm) |
| Mounting Method: | 2 x fixing screws for mounting plate |
| Mounting Holes: | 65.5mm hole spacing |
| Mounting Surface: | Optimised for flat non-metallic surfaces |
| Cavity Cable Entry Hole: | Up to 20mm |
| Installation Environment: - | 35°C to 65°C @15% - 90% relative humidity (non-condensing) |
| Ingress Protection: | IP67 |

Reader Protocols

| | |
|------------------------|--|
| Device Communications: | Open Supervised Device Protocol (OSDP) |
| Operating Frequency: | 13.56 Mhz |
| Credentials: | Mifare DESFire© EV1/EV2 with AES encryption |
| Credentials: | Read Card Serial Number (CSN) from 3rd party cards (MF Model Only) |

Connections

| | |
|------------------------------------|---|
| Pigtail Cable Length: | 500mm |
| Pigtail Extension Cable Type: | 2-pair 7/0.20 twisted pair data cable as minimum. 2-pair 14/0.20 multi-strand shielded twisted pair data cable is preferred (e.g. Belden 8723). See installation manual for more info. |
| Connection Methods: | RS-485 multi-drop star or daisy chain configurations |
| Total Overall Cable Length: | 1000 meters total on one RS-485 reader port guaranteed |
| Max Readers: | Up to 16 with IAC & ILAM, Up to 4 with SLAM |
| Compatible Integriti Host Modules: | Standard LAN Access Module (SLAM), Intelligent LAN Access Module (ILAM), Integriti Access Controller (IAC) |

Reader Security

| | |
|--------------------------|---|
| Physical Tamper: | Optical beam to mounting surface |
| Card to Reader: | 128bit AES encryption |
| Reader to Access Module: | 128bit AES encryption |
| Vandal Resistance: | Fully encapsulated vandal resistant electronics |

Reader Configuration

| | |
|-------------------------|--|
| LAN Addressing: | Fully automatic when used with Integriti systems Manual addressing with 3rd party OSDP compatible systems |
| Firmware Updates: | Over-the-wire firmware updates when used with Inner Range systems |
| Reader Purpose Options: | Control a Door, Control a Lift, Log on, Area status toggle |

Keypad, LED & Beeper Indicators

| | |
|---------------------------|---|
| Keypad: | Backlit auto-dimming silicon rubber keypad with a highly tactile operation feel |
| LED Configuration: | Brightness, Colours & Feedback modes - configurable via Integriti Software |
| LED 1 & 2 Colour Options: | RGB Indicator 23 colour selectable |
| Feedback Modes for LED's: | Area Status, Area Alarm/Isolated, Entry/Exit Delay, Door open/locked status, Valid/Invalid card badge, No LED's |
| Beeper Volume: | Variable - configurable via Integriti software |
| Beeper Feedback Options: | Valid/Invalid card badge, Door Open tool long (DOTL), Area Alarm, Entry/Exit Delay |

Power Requirements

| | |
|---------------------|---|
| Power supply | 11V-14V DC < 500mV ripple |
| Current consumption | 75mA – 115 mA, 165 mA max, depends on LED's configuration |

Compliance

| | |
|----------------|--|
| Electrical: | |
| Environmental: | |

***SIFER-C cards are programmed with a custom encryption key and will require at least one SIFER Reader Configuration card with the initial batch. The SIFER Reader Configuration Card is available under Part Number 994614CNF*

Ordering Options



- 994725**
SIFER Keypad/Smart Card Reader
- 994725MF**
SIFER Keypad/Smart Card Reader - Multi Format Version

Credentials

ISO Cards



- 994610**
SIFER-P DESFire© EV2 4K ISO (Pre-programmed - Printed)
- 994612**
SIFER-U DESFire© EV2 4K ISO (User Programmable - Printed)
- 994614****
SIFER-C DESFire© EV2 4K ISO (Custom Programmed - Printed)

994580

- ECOLITE** MIFARE Ultralight EV1 (Pre-programmed)

FOB's



- 994616**
SIFER-P DESFire© EV2 4K FOB (Pre-programmed - Printed)
- 994618**
SIFER-U DESFire© EV2 4K FOB (User Programmable - Printed)
- 994620****
SIFER-C DESFire© EV2 4K FOB (Custom Programmed - Printed)



Management Tools

- 994750** SIFER Card Programming Station
- 994751** SIFER Card Enrolment Station

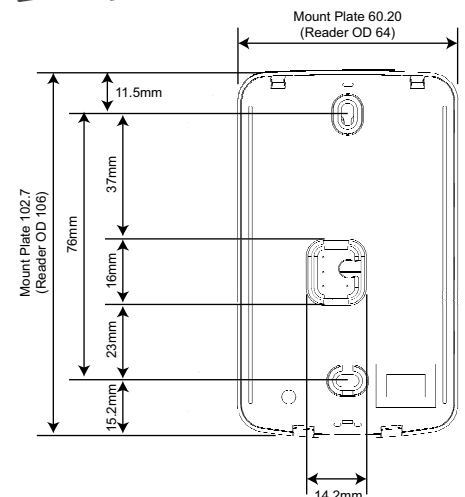

A wide variety of credentials are available to suit Inner Range SIFER card readers. SIFER credentials are available in various form factors for use with physical and logical access control systems. All SIFER credentials use the highly secure MIFARE® DESFire® EV2 card format. Form factor types for SIFER credentials include: ISO Cards, Key Fobs, self-adhesive Tags/Coils and Wristbands. Three ordering options are available for each form factor type.



SIFER-P: Pre-programmed ‘Stock’ Credentials.

SIFER-P credentials are pre-programmed with the Inner Range Global Encryption Key and can be used with standard SIFER Readers without any need for card or reader configuration. SIFER-P credentials are supplied with a pre-programmed site code and a card number that is guaranteed to be unique and are ‘locked’ to disallow re-programming in the field. SIFER-P credentials are supplied with the SIFER-P mark and are printed with the unique card number.

SIFER-U: User-programmable Credentials.

SIFER-U credentials have an identical set of specifications to that of SIFER-P with the major difference being that they can be re-programmed in the field. By default SIFER-U credentials are shipped pre-programmed with the Inner Range SIFER Global Encryption Key and can be used with standard SIFER Readers without any need for card or reader configuration. Although SIFER-U credentials are supplied pre-programmed, the site code and encryption key can be re-programmed in the field using a SIFER card programming station. (It is not recommended to re-program SIFER-U card numbers as they are already unique)

When SIFER-U credentials have been re-programmed, the SIFER readers must also be re-configured to use the same encryption key. To perform the Reader configuration a “Reader Configuration Card” must be produced using the SIFER card programming station.

SIFER-U customisation is a process that is carried out by the installer and as such the unique encryption key must be stored and managed for safekeeping by the installer, this facilitates additional card batches at a future date. Where a unique SIFER-U encryption key has been lost it cannot be recovered.

SIFER-U: Gold Card Service.

As an alternative to the installer specifying their own custom encryption key, Inner Range offers a ‘Gold Card’ service, providing the installer with a unique Gold Key Configuration Card (‘Gold Card’). The Gold Card delivers a guaranteed unique custom encryption key for use with the SIFER programming station and SIFER-U credentials. Inner Range assigns a unique encryption key from the reserved ‘Gold Card’ range. The encryption key is then associated with the customer’s site to facilitate future card orders. The encryption key is securely stored within Inner Range where it cannot be viewed or shared. Being a reserved key, the key can never be manually entered using a SIFER programmer.

SIFER-C: Custom Programmed Credentials & Reader Configuration Cards.

The SIFER-C option allows installers to order reader configuration cards and user credentials from the factory with specific custom programming. SIFER-C allows the card number range, site code and encryption key to be programmed to order. SIFER-C card numbers are guaranteed to be unique and are ‘locked’ to disallow credential re-programming in the field. SIFER-C credentials are supplied with the SIFER-C mark and are printed with the unique card number. Where SIFER-C credentials are to be deployed the SIFER readers/keypads on the site must also be re-configured to use the matching encryption key. To accommodate this a Reader Configuration Card (994614CNF) is also required.

ECOLITE: Budget-friendly, Less Secure.

ECOLITE is a budget range of credentials that is compatible with Inner Range SIFER Readers, Integriti & Inception systems. These credentials are based on the MIFARE Ultralight EV1 technology which is a lower priced - lower security option compared to the standard DESFire EV1/EV2 technology used in our SIFER-P, SIFER-U & SIFER-C range of credentials.

Ordering Options

Standard SIFER Credentials. All credentials are MIFARE® DESFire® EV2 4K - ECOLITE Cards are MIFARE Ultralight EV1 technology



ISO Cards
SIFER-P ISO Card **994610**
SIFER-U ISO Card **994612**
SIFER-C ISO Card **994614**
ECOLITE ISO Card **994580**



Silicon Wrist Bands
SIFER-P Wristband **994625P**
SIFER-U Wristband **994625U**
SIFER-C Wristband **994625C**

Special Order Multi Application Cards & Fobs*
994614A Dual Application ISO card SIFER/Aperio
994614H Dual Application ISO card SIFER/HID
994614AH Tri Application ISO card SIFER/Aperio/HID



Key Fobs
SIFER-P Key Fob **994616**
SIFER-U Key Fob **994618**
SIFER-C Key Fob **994620**



SIFER-U Gold Card
994612G for use with SIFER-U credentials

994620A Dual Application Key Fob SIFER/Aperio
994620H Dual Application Key Fob SIFER/HID
994620AH Tri Application Key Fob SIFER/Aperio/HID
**All multi-application credentials must be based on MIFARE® DESFire® EV1/EV2 media (56 bit)*



Self Adhesive 20mm Coils
SIFER-P Tag/Coil **994621P**
SIFER-U Tag/Coil **994621U**
SIFER-C Tag/Coil **994621C**



SIFER Reader Configuration Card
994614CNF for use with SIFER-C credentials & SIFER readers and Keypad Readers

The OSDP <> Wiegand Converter is a small inline device, capable of operating in two main modes that can open up many new options when determining and designing a site's hardware requirements.

Option 1: Connect Wiegand readers to OSDP ports via the Converter

A Wiegand reader can now be connected to an OSDP port. This allows Wiegand readers to make use of many of the benefits that an OSDP reader bus provides:

- 128bit AES encrypted communication path
- 4-core cables to the module, while still offering beeper, valid and invalid LED control
- Longer cable runs
- More flexible wiring configurations (for example, daisy-chaining readers together for a single run back to the module).

In practice, this allows up to 16 Wiegand readers to be connected directly to an Integrati Access Module (4 for SLAM), allowing read-in and read-out abilities on all doors. This is perfect if upgrading an existing site with access control to Integrati.

The advanced control that Integrati offers for a Wiegand reader's beeper and valid/invalid LEDs are also available when connected to the OSDP <> Wiegand Converter. This allows numerous area events like arm success or failure, entry delay, exit delay, alarm and area arm warning, or door events like door unlocked and held open too long to make use of the inbuilt Wiegand reader's beeper and LEDs to provide feedback to users.

Option 2: Connect OSDP readers to Wiegand reader port.

Via the Converter, OSDP readers such as Inner Range SIFER readers or other products can now be connected to existing Wiegand reader ports. This allows SIFERs, for example, to be used on older Concept access modules where the system is being upgraded to use an Integrati ISC/IAC Controller.

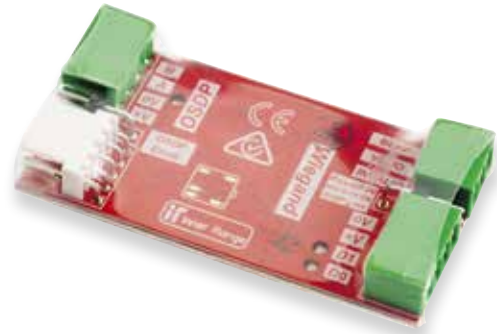

Connectivity

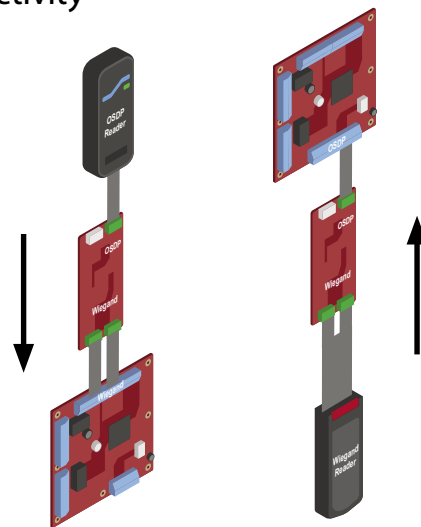

Ordering Options



994200
OSDP <> Wiegand Converter

Specifications

Physical

| | |
|---------------------------|---|
| PCB Size: | 85(L) x 35(W) x 15(D) (mm) Including connectors |
| Shipping Weight: | 42grams (Circuit Board & Accessories) |
| Mounting Method: | Within a secure location - can be mounted using velcro strips |
| Installation Environment: | 0° to 65° Celsius. 15-85% Relative humidity (non-condensing) |

Reader Protocols

| | |
|------------------------|-----------------------|
| Device Communications: | OSDP, SIFER & Wiegand |
|------------------------|-----------------------|

Connections

| | |
|-----------------------|--|
| OSDP Port: | 4 pin connector +V, 0v, A, B |
| Wiegand Reader: | 4 pin connector D0, D1, +V, 0 |
| Wiegand LED & Beeper: | 3 pin connector Invalid LED, Valid LED, Beeper |
| Port 0: | 5 pin connector to suit Port 0 cable (993030USB) |

Reader Security

| | |
|--------------------------|-----------------------|
| OSDP Communications Bus: | 128bit AES encryption |
|--------------------------|-----------------------|

Device Configuration

| | |
|-------------------------------|---|
| Configurable options include: | RS-485 OSDP Baud Rate, Wiegand bit length, OSDP reader primary LED colour, OSDP reader 2nd LED colour, SIFER reader LED brightness, SIFER reader speaker volume |
|-------------------------------|---|

Power Requirements

| | |
|----------------------|--|
| Input: | 11-14V DC |
| Current Consumption: | Idle 20mA - Peak 35mA (Not including any connected readers, LEDs or beepers) |

Compliance

| | |
|----------------|--|
| Electrical: | |
| Environmental: | |

Features

- Convert Wiegand to OSDP format
- Convert OSDP to Wiegand format
- Auto reader enrollment in OSDP to Wiegand mode
- Configurable via HyperTerminal using a Port 0 Cable (993030USB)
- Configurable options include:
 - RS-485 OSDP Baud Rate
 - Wiegand bit length
 - OSDP reader primary LED colour
 - OSDP reader 2nd LED colour
 - SIFER reader LED brightness
 - SIFER reader speaker volume

The SIFER Card Programming Station is an installer tool featuring a USB connected SIFER programming head, which is used in conjunction with the accompanying SIFER Card Programming Software. This system allows SIFER “User Programmable” cards, known as SIFER-U cards to be encoded with customised site codes and encryption keys by the installer. The programming station is also used to create the SIFER Reader Configuration Card which is necessary to configure SIFER readers to decrypt the sites unique encryption key.

SIFER-U cards are available as ISO style cards or FOBs and are readily available from Inner Range distributors. Before leaving the Inner Range factory each SIFER-U cards is pre-programmed, with a standard encryption key, site code and unique card number. This allows SIFER-U cards to be used in the field as they are, or they can be encoded to the installer’s requirements using the SIFER Programming Station.

The SIFER Programmer allows the installer to encode card details of their own choosing, and the following aspects can be changed:

- Site Code
- Encryption Key (32 HEX Digits)

It is also possible to change the card number, however this is usually unnecessary as every SIFER-U card already carries a unique card number which is etched onto the card. If a SIFER-U cards standard site code or card number are to be changed, the default encryption key must also be changed.

Encoding Parameters

- Site Codes: Between 1 – 16.7 million (16,777,215) (some site codes are reserved for Inner Range use)
- Encryption Key: Specified 32 digit hexadecimal string or automatically generated by the Card Programming Software
- Card Numbers: Between 1– 4.3 billion (4,294,967,295)



Specifications

Electrical Specifications

| | |
|----------------------|-------------------------|
| Power Supply Source: | 5V DC from PC USB Port. |
| Output to PC: | USB 2.0 |

Mechanical Specifications

| | |
|---|------------|
| The SIFER Card Programming Station is supplied as a desktop unit which may be wall mounted if required. | |
| Dimensions: Length: | 190mm |
| Width: | 134mm |
| Height: | 65mm |
| USB Cable length: | 1.5 metres |
| Shipping Weight: | 520grams |

Installation environment should be maintained at a temperature of 0° to 50° Celsius and 15% to 90% Relative humidity (non-condensing)

Software

| | |
|-------------------------------|---|
| Programming Station Software: | Windows software, downloadable from Inner Range website |
|-------------------------------|---|

SIFER-U Tag/Coil **994621U**



SIFER-U Wristband **994625U**



SIFER-U Gold Card

994612G for use with SIFER-U credentials

Ordering Options

Management Tools

994750 SIFER Card Programming Station



Credentials

ISO Cards

994612
SIFER-U DESFire© EV2 4K ISO
 (User Programmable - Printed)



FOB's

994618
SIFER-U DESFire© EV2 4K FOB
 (User Programmable - Printed)



The SIFER Card Enrollment Station is designed to conveniently allow SIFER cards to be enrolled into an Inner Range Integriti system at a computer workstation using the Integriti software.

This allows system administrators to enroll new SIFER cards into the Integriti system without the need to physically enter the card data into the system.



Specifications

Electrical Specifications

| | |
|---|-------------------------|
| Power Supply Source: | 5V DC from PC USB Port. |
| Output to PC: | USB 2.0 |
| Integriti/Infiniti Software Compatibility | V4.1 or later. |

Mechanical Specifications

The SIFER Card Programming Station is supplied as a desktop unit which may be wall mounted if required.

| | |
|---------------------|------------|
| Dimensions: Length: | 190mm |
| Width: | 134mm |
| Height: | 65mm |
| USB Cable length: | 1.5 metres |
| Shipping Weight: | 520grams |

Installation environment should be maintained at a temperature of 0° to 50° Celsius and 15% to 90% Relative humidity (non-condensing)

Ordering Options

Management Tools

994751 SIFER Card Enrollment Station



The Integriti 8 Zone LAN Expander Module connects directly to the Integriti or RS-485 LAN and provides an additional 8 Zone Inputs, 2 Auxiliary Outputs and 2 Siren drivers. Up to 99 Zone Expander Modules can be connected to the RS-485 LAN or via IP LAN if connected using Ethernet Bridge or CLOE devices.**

The 8 Zone LAN Expander Module also offers a UniBus in-cabinet expansion interface allowing further expansion of Zone Inputs and Auxiliary Outputs using plug on UniBus expansion devices fitted within the same tamper-protected enclosure. Up to 32 Zone Inputs or 32 Auxiliary Outputs can be connected to the Module (32 Zones and 26 Auxiliaries or 24 Zones and 32 Auxiliaries at the same time).

The power supply requirement is 11 to 14VDC and a range of Integriti plug on external 2Amp, 3Amp or 8Amp switch mode power supplies are available. Integriti external power supplies are fully monitored via the 8 Zone Expander Module.

*** Where it is necessary to connect large numbers of Zone Expanders to the Integriti RS-485 LAN, the use of LAN Isolators or other LAN retransmission devices such as Fibre Modems, Ethernet Bridge or CLOE modules is recommended.*

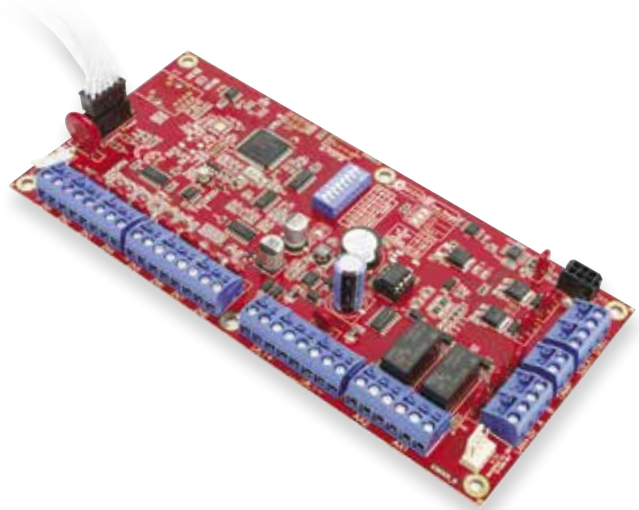

| UniBus Device Compatibility Guide | UniBus Host Module | | | |
|-----------------------------------|--------------------|-----|-----------------|------|
| | ISC | IAC | 8 Zone Expander | ILAM |
| 8 Zone Expander | 2 | 0 | 3 | 0 |
| 8 Relay Expander | 4 | 2 | 4 | 2 |
| 2 Door / 2 Reader Expander | 0 | 3 | 0 | 3 |
| 16 Floor Lift Interface | 6 | 6 | 6 | 6 |
| RS-232/RS-485 UART | 4 | 4 | 0 | 0 |
| Analogue Expander | 4 | 0 | 6 | 0 |

Features

- RS-485 LAN connectivity
- UniBus In-Cabinet Expansion Interface
- 8 Zone Inputs - Multistate or Analogue
- 2 Auxiliary Output Relays
- External Integriti power supply connection
- Three options for power supply size 2Amp, 3Amp & 8Amp
- Six enclosure size options
- Dedicated Tamper Input
- Internal & External variable tone Siren Outputs
- 4 Terminals supplying 13.75VDC nominal Detector Power
- Over-The-Wire firmware upgradable
- On-board diagnostic LED's to assist with commissioning and troubleshooting
- Small PCB size 200 x 95mm
- Built-in module locator buzzer

Expansion Capabilities

- Zone Inputs - Expandable to 32 via UniBus***
- Auxiliary Outputs (Relays) - Expandable to 32 via UniBus***

****32 Zones and 26 Auxiliaries or 24 Zones and 32 Auxiliaries at the same time*

Connectivity

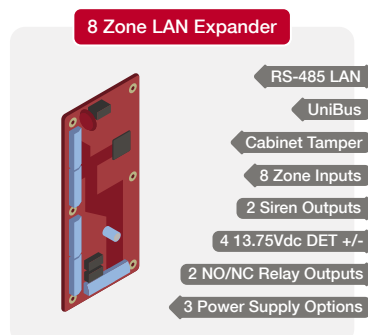

Specifications

Physical

| | |
|---------------------------|--|
| Enclosure Options: | XSmall - 252(L) x 263(W) x 85(D) (mm): Part# 995200XS |
| | Small - 252(L) x 358(W) x 85(D) (mm): Part# 995200PE2 or 995200PE3 |
| | Medium - 460(L) x 358(W) x 85(D) (mm): Part# 995201PE2, 995201PE3 or 995201PE8 |
| | XLarge - 702(L) x 358(W) x 85(D) (mm): Part# 995203PE2, 995203PE3 or 995203PE8 |
| | WideBody - 580(L) x 510(W) x 95(D) (mm): Part# 995204PE3 or 995204PE8 |
| | Rack Mount - 2RU 680(L) x 420(W) x 85(D) (mm): Part# 995220PE2, 995220PE3 or 995220PE8 |
| PCB Size Code: | Integriti "B" size |
| PCB Dimensions: | 200(L) x 94(W) x 45(D) (mm) |
| Shipping Weight: | 260grams (Circuit Board and Accessories only) |
| Installation Environment: | 0°C - 70°C @15% - 90% Relative humidity (non-condensing) |

Electrical (For PCB Only)

| | |
|---|---|
| Power Supply Input: | 11V to 14VDC |
| Current Consumption: | 60mA standby, 100mA with both Aux relays on |
| NOTE: Current consumption does not include the current required by detectors or other external devices such as buzzers, lamps or any device attached to the DET+, LAN+ and UniBus connections | |

Contact Ratings

| | |
|-------------|----------------|
| Aux Relays: | 2 Amps @ 30VDC |
|-------------|----------------|

Connections

| | |
|-----------------|---|
| Zone Inputs: | 8 x Multistate Zone Inputs |
| Aux Outputs: | 2 x Relay Output: NO COM NC |
| Cabinet Tamper: | 2 pin connection for cabinet tamper switch |
| UniBus Port: | 1 x UniBus Host expansion port |
| RS-485 LAN: | 1, Includes LAN+, LAN-, A, B. (LAN addressing set via DIP switches) |
| Siren Outputs: | 1 x Internal & 1 x External variable tone Siren Outputs* |
| Power Supply: | 1 x Integriti External Power Supply Connection |
| Power Outputs: | 4 x 13.75Vdc nominal outputs (DET+/DET- Detector Power) |

External Power Supply Monitoring (Compatible with IR SMART PSU Devices)

| | |
|----------------|---------------------------|
| AC Fail: | External PS AC Fail |
| Low Battery: | External PS Low Battery |
| LAN Fuse: | External PS LAN Fuse |
| Detector Fuse: | External PS Detector Fuse |
| Low Volts: | External PS Low Volts |
| PSU Fail: | External PS Fail |

Compliance

| | |
|---------------|--|
| Electrical | |
| Environmental | |

*Siren drivers fitted from PCB revision "B"

Ordering Options



996005PCB&K
8 Zone LAN Expander Module PCB & Kit

UniBus expansion options to suit above
See separate data sheets for UniBus devices

996500PCB&K
UniBus 8 Zone Expansion device

996515PCB&K
UniBus 8 Relay(Aux) Expansion device

996540PCB&K
UniBus 16 Floor Lift Interface device

Enclosure Options



995200PE3
small
enclosure
shown

Enclosures

| |
|-----------------------------|
| Small |
| 995200PE2 - 2Amp PSU* |
| 995200PE3 - 3Amp SMART PSU* |
| Medium |
| 995201PE2 - 2Amp PSU* |
| 995201PE3 - 3Amp SMART PSU* |
| 995201PE8 - 8Amp SMART PSU |
| XLarge |
| 995203PE2 - 2Amp PSU* |
| 995203PE3 - 3Amp SMART PSU* |
| 995203PE8 - 8Amp SMART PSU |

Spare Mounting Plates for Medium, Large and WideBody Enclosures

| |
|--|
| 999026 - Medium mounting plate to suit Integriti PCB's |
| 999023 - Medium mounting plate to suit Concept PCB's |
| 999006 - Large mounting plate to suit Concept or Integriti PCB's*** |
| 999027 - 2nd tier hinged expansion plate to suit WideBody enclosure |

WideBody

| |
|---------------------------------|
| 995204PE3 - 3Amp SMART PSU* |
| 995204PE8 - 8Amp SMART PSU |
| Rack Mount Drawer |
| 995220PE2 2RU - 2Amp PSU* |
| 995220PE3 2RU - 3Amp SMART PSU* |
| 995220PE8 2RU - 8Amp SMART PSU |

Please see enclosure section or website for further details on enclosures.

* Additional external power may be required for 2 and 3Amp models.

*** Suitable for 995203 series enclosures only

The UniBus 2 Door / 2 Reader Expander can be used to provide control and monitoring of 2 additional Doors or Readers on a compatible UniBus host module. When connected to the Integriti Intelligent LAN Access Module, the UniBus 2 Door / 2 Wiegand Reader expander can provide installation configurations for 4, 6 or 8 doors. SIFER or third party OSDP RS-485 readers can be assigned via the host module for Read In & Read Out access control on each door.

The UniBus 2 Door / 2 Reader Expander is designed for installation within the same tamper-protected enclosure as its UniBus host module. The UniBus device is connected directly to the host module or daisy-chained to another UniBus device via the UniBus patch cable supplied. Up to 3 UniBus 2 Door / 2 Reader Expander devices can be connected.

Host Module Compatibility

The UniBus 2 Door / 2 Reader Expander is compatible with the following UniBus Host Modules:

- Integriti Intelligent LAN Access Module (Part. 996018PCB&K)
- Integriti IAC Controller (Part. 996035PCB&K)

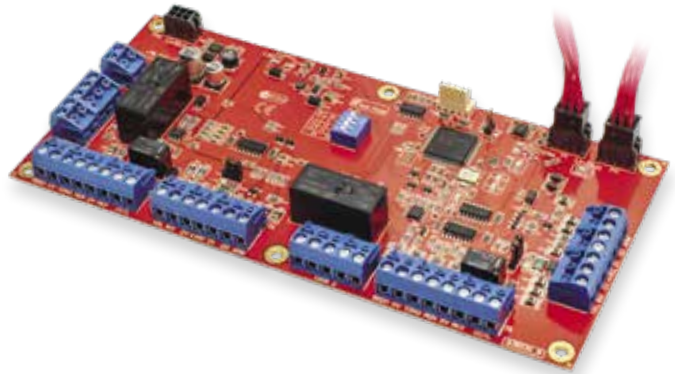

| UniBus Device Compatibility Guide | UniBus Host Module | | | |
|-----------------------------------|--------------------|----------|-----------------|----------|
| | ISC | IAC | 8 Zone Expander | ILAM |
| 8 Zone Expander | 2 | 0 | 3 | 0 |
| 8 Relay Expander | 4 | 2 | 4 | 2 |
| 2 Door / 2 Reader Expander | 0 | 3 | 0 | 3 |
| 16 Floor Lift Interface | 6 | 6 | 6 | 6 |
| RS-232/RS-485 UART | 4 | 4 | 0 | 0 |
| Analogue Expander | 4 | 0 | 6 | 0 |

Features

- Provides an additional 2 Doors / 2 Wiegand Readers for Host Module
- Assign Read In & Read Out SIFER or third party OSDP RS-485 readers for each door via the Host Module
- UniBus connectivity to Host Module
- Reader options to control Doors, Lifts, Areas and User Logon
- Supports Wiegand card readers up to 88bits
- Reader outputs with individual self-resetting over current protection
- UniBus loop-through connectors
- LED Status & Fault Indicators
- Dedicated lock power input
- Heavy duty lock relays
- Reader Valid & Invalid Outputs
- Door reed & tongue sense inputs per door
- Door request to enter & exit inputs per door
- DOTL relay outputs per door
- Integriti "B" size footprint 200 x 94mm

Connectivity

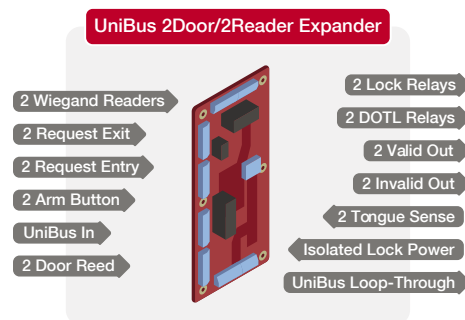

UniBus Installation

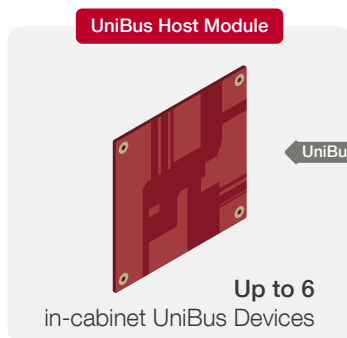

UniBus Devices are designed for installation within the same enclosure as the UniBus host module. A UniBus host can interface a maximum of six UniBus devices in any combination, provided they are all within the intended functionality of the host module

Specifications

Physical

| | |
|---------------------------|--|
| PCB Size Code: | Integrati "B" size |
| PCB Size: | 200(L) x 94(W) x 45(D) (mm) |
| Height: | 20(D) (mm) (45mm with UniBus cable connected) |
| Shipping Weight: | 290grams |
| Installation Environment: | 0°C - 70°C @15% - 90% Relative humidity (non-condensing) |

Electrical

| | |
|----------------------|----------------------------------|
| Power Supply Input: | 11V to 14VDC via host module |
| Current Consumption: | 40mA idle |
| | 110mA both lock relays on |
| | 135mA both lock & DOTL relays on |

NOTE: Current consumption does not include the current required by readers or other external devices such as locks, buzzers, lamps or any device attached to the DOTL, Valid, Invalid, RS-485 Reader and UniBus connections

| | |
|--------------------------|---|
| Over Current Protection: | Reader +V connections. Protected with self-resetting PTCs |
|--------------------------|---|

Contact Ratings

| | |
|--------------|---|
| Lock Relays: | 5 Amps @ 30VDC |
| DOTL Relays: | 1 Amp @ 30VDC (Door Open Too Long output) |

Connections

| | |
|-----------------------|---|
| Lock 1 & 2: | Includes Lock+, Lock-, NO/COM/NC |
| Door 1 & 2: | Includes Reed, 2 x 0v, Tongue, REN, REX, DOTL contacts |
| Wiegand Reader 1 & 2: | Includes Valid, Invalid, 0V, Reader+, D1, D0, ARM |
| Lock Power: | Includes Lock+, Lock- connections from external PSU |
| UniBus Port: | 3 x UniBus connections for loop-through and connection to host module |

Power Considerations

The UniBus host module supplies static device current to all connected UniBus devices.

Total current consumption is, therefore the sum of all:

- Static Current of all connected UniBus devices
- Static Current of host module
- Host module battery charging current
- Card Readers and Ancillary devices connected to DOTL, Valid & Invalid connections

Lock Power Considerations

Lock power is supplied directly from an Integrati SMART PSU (Housed in the same enclosure) and is the sum of the maximum current required by all connected locking device hardware.

Compliance

Electrical



Environmental



Ordering Options



996535PCB&K
Integrati UniBus 2 Door Expander PCB & Accessories (Includes 270mm UniBus patch cable)



Spare UniBus patch cables
9967915S - UniBus Patch Cable 150mm
9967915 - UniBus Patch Cable 220mm
996791L - UniBus Patch Cable 270mm
996791LL - UniBus Patch Cable 475mm
996791XL - UniBus Patch Cable 675mm

The UniBus 8 Zone Expander connects to an Integrati Security Controller (ISC) or an 8 Zone LAN Expander via the UniBus Port. It provides an additional 8 Zone Inputs that support all Integrati Zone Types including Multistate and Counter types along with extra detector power supply connections (DET+) to simplify device wiring.

The UniBus 8 Zone Expander is designed for installation within the same tamper-protected enclosure as its UniBus host module. The UniBus device is connected directly to the host module or another UniBus device via the UniBus patch cable supplied.

Host Module Compatibility

The UniBus 8 Zone Expander is compatible with the following UniBus Host Modules:

- Integrati ISC Controller (Part. 996001 series) - Connect up to 2
- Integrati 8 Zone RS-485 LAN Expander (Part. 996005PCB&K) - Connect up to 3

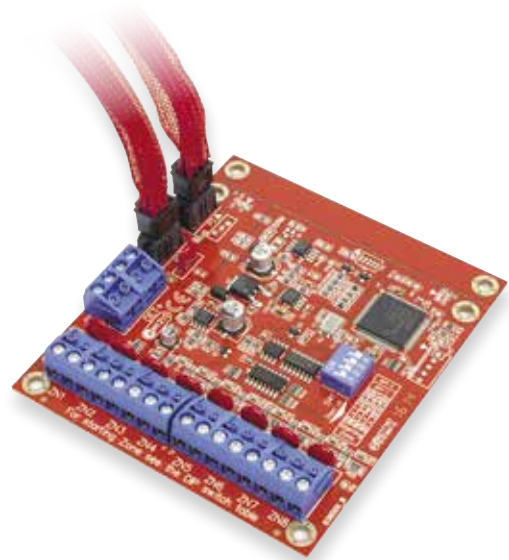

| UniBus Device Compatibility Guide | | UniBus Host Module | | | |
|-----------------------------------|----------------------------|--------------------|-----|-----------------|------|
| | | ISC | IAC | 8 Zone Expander | ILAM |
| UniBus Device | 8 Zone Expander | 2 | 0 | 3 | 0 |
| | 8 Relay Expander | 4 | 2 | 4 | 2 |
| | 2 Door / 2 Reader Expander | 0 | 3 | 0 | 3 |
| | 16 Floor Lift Interface | 6 | 6 | 6 | 6 |
| | RS-232/RS-485 UART | 4 | 4 | 0 | 0 |
| | Analogue Expander | 4 | 0 | 6 | 0 |

Features

- 8 Universal Zone Inputs
- Support for Multistate EOL circuits
- Support for counter type inputs
- Programmable de-bounce times
- DIP switch addressable first zone 1, 9, 17 or 25
- UniBus loop-through connectors
- 4Way DET+ 13.75V outputs
- 2 LED status/fault indicators
- Surge protected inputs
- Over-The-Wire firmware upgradable
- Integrati "C" size footprint 94 x 94mm
- Can be installed above other "C" size PCBs**
- A Snap off strip is included to allow installation above Integrati "B" size PCBs**

Connectivity

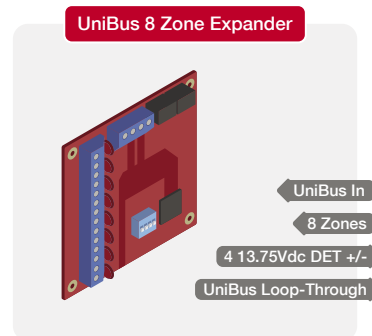

** 35mm standoff kit required - Part Number 999009

UniBus Installation

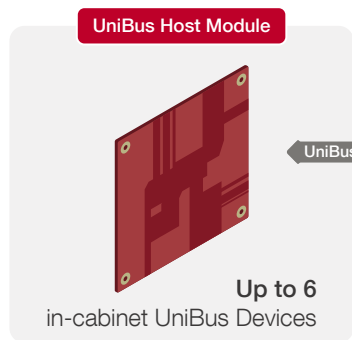

UniBus Devices are designed for installation within the same enclosure as the UniBus host module. A UniBus host can interface a maximum of six UniBus devices in any combination, provided they are all within the intended functionality of the host module

Specifications

Physical

| | |
|------------------------------------|--|
| PCB Size Code: | Integriti "C" size |
| PCB Size: | 94(L) x 94(W) (mm) |
| PCB size including snap off strip: | 105(L) x 94(W) (mm) |
| Height: | 15(D) (mm) (28mm with UniBus cable connected) |
| Shipping Weight: | 100grams |
| Installation Environment: | 0°C - 70°C @15% - 90% Relative humidity (non-condensing) |

Electrical

| | |
|-----------------------------|--|
| Power Supply Input: | 11V to 14V DC via host module |
| Static Current Consumption: | 75mA. (not including detector power) |
| DET+: | Output Voltage 13.75V DC - sourced from host |
| DET+ Output Current: | Limited to available current from host |

Connections

| | |
|----------------------------|--|
| Zone Inputs: | 8 |
| DET+ Out: | 4 |
| UniBus Port: | 1 |
| UniBus Loop-through Port: | 1 |
| Connection to Host Module: | Via 270mm UniBus patch lead (supplied) |

Power Considerations

The UniBus host module supplies DET+ current and static device current to all connected UniBus devices. Total current consumption is, therefore the sum of all:

- Static Current of all connected UniBus devices
- Static Current of host module
- Host module battery charging current
- Ancillary devices connected to all DET+ connections
- Ancillary devices connected to host module's RS-485 LAN+

Compliance

Electrical



Environmental



Ordering Options

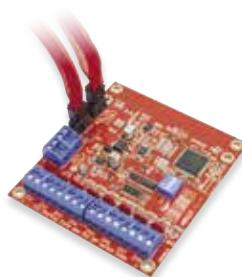

996500PCB&K

Integriti UniBus 8 Zone Input Expander PCB & Accessories (Includes 270mm UniBus patch cable)

Spare UniBus patch cables

- 996791SS** - UniBus Patch Cable 150mm
- 996791S** - UniBus Patch Cable 220mm
- 996791L** - UniBus Patch Cable 270mm
- 996791LL** - UniBus Patch Cable 475mm
- 996791XL** - UniBus Patch Cable 675mm

The UniBus 4 Way Analogue Input Expander provides the capability to monitor, report and action on analogue values within an Integriti system. The device can be programmed to operate an auxiliary when an analogue level from one or more of its independent analogue inputs exceeds or goes below a pre-programmed trigger point. Analogue levels can be monitored and controlled in scaled units through the Integriti software or at any EliteX Terminal.

The Analogue input device is hosted via a UniBus connection to the Integriti Security Controller (ISC) or the Integriti 8 Zone LAN Expander. The device is designed for installation within the same tamper-protected enclosure as its UniBus host module.

Each of the 4 inputs can be configured to operate in any one of 3 modes

- 1) Serial Mode - For use with the Inner Range Serial Temperature Sensor (Part. 995089)
- 2) Voltage Monitor Mode - For monitoring voltages from 0 to 10V DC
- 3) Current Loop Monitor Mode - For monitoring current from 4 to 20mA DC

The Analogue Module allows the programmer or installer a variety of selectable mode settings and levels with which to configure the system to the particular application. The trigger point, output auxiliary, tamper levels and hysteresis values may be individually selected for each input.

Host Module Compatibility

The UniBus 4 Way Analogue Input Expander is compatible with the following UniBus Host Modules:

- Integriti ISC Controller (Part. 996001 series) - Connect up to 4
- Integriti 8 Zone RS-485 LAN Expander (Part. 996005PCB&K) - Connect up to 6



| UniBus Device Compatibility Guide | UniBus Host Module | | | |
|-----------------------------------|--------------------|----------|-----------------|----------|
| | ISC | IAC | 8 Zone Expander | ILAM |
| 8 Zone Expander | 2 | 0 | 3 | 0 |
| 8 Relay Expander | 4 | 2 | 4 | 2 |
| 2 Door / 2 Reader Expander | 0 | 3 | 0 | 3 |
| 16 Floor Lift Interface | 6 | 6 | 6 | 6 |
| RS-232/RS-485 UART | 4 | 4 | 0 | 0 |
| Analogue Expander | 4 | 0 | 6 | 0 |

Features

- 4 Universal Analogue Zone Inputs
- 3 mode options per input - Serial, Voltage or Current loop
- Compatible with Inner Range Serial Temperature Sensor (Part. 995089 - See page 72)
- Programmable hysteresis setting
- DIP switch addressable first zone 1, 5, 9, 13, 17, 21, 25, 29
- 24V DC output for current loop supply
- UniBus loop-through connectors
- 2 LED status/fault indicators
- Resettable surge protected inputs
- Over-The-Wire firmware upgradeable
- Integriti "C" size footprint 94 x 94mm
- Can be installed above other "C" size PCBs**
- A Snap off strip is included to allow installation above Integriti "B" size PCBs**

** 35mm standoff kit required - Part Number 999009

Connectivity

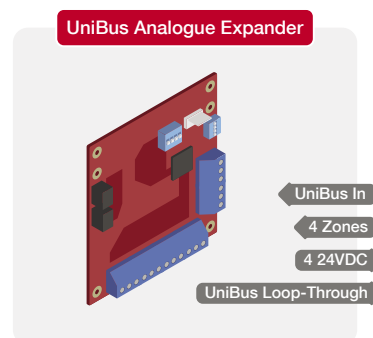

UniBus Installation

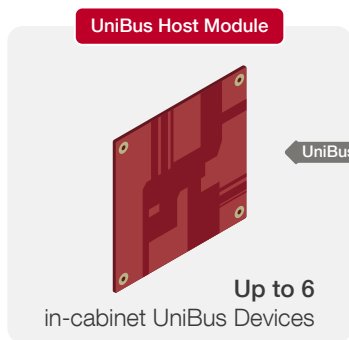

UniBus Devices are designed for installation within the same enclosure as the UniBus host module. A UniBus host can interface a maximum of six UniBus devices in any combination, provided they are all within the intended functionality of the host module

Specifications

Physical

| | |
|------------------------------------|--|
| PCB Size Code: | Integriti "C" size |
| PCB Size: | 94(L) x 94(W) (mm) |
| PCB size including snap off strip: | 105(L) x 94(W) (mm) |
| Height: | 15(D)(mm) (28mm with UniBus cable connected) |
| Shipping Weight: | 100grams |
| Installation Environment: | 0°C - 70°C @15% - 90% Relative humidity (non-condensing) |

Electrical

| | |
|-----------------------------|---|
| Power Supply Input: | 11V to 14V DC via host module |
| Static Current Consumption: | 50mA idle ~ 230mA (Max with all inputs in loop mode supplying 20mA per input) |
| CL+ Outputs: | 24V DC Current Loop Output Voltage |
| 1W+ Output: | 5VDC for connection to +DAL on 995089 Serial Temperature Sensor |

Connections

| | |
|----------------------------|--|
| Analogue Inputs: | 4 |
| CL+: | 1 per Input |
| 1W+: | 1 |
| Serial Sense Inputs | 4 |
| UniBus Port: | 1 |
| UniBus Loop-through Port: | 1 |
| Connection to Host Module: | Via 270mm UniBus patch lead (supplied) |

Power Considerations

The UniBus host module supplies current and static device current to all connected UniBus devices. Total current consumption is, therefore the sum of all:

- Static Current of all connected UniBus devices
- Static Current of host module
- Host module battery charging current
- Ancillary devices connected to all DET+, CL+, 1W+ connections
- Ancillary devices connected to host module's RS-485 LAN+

Compliance

Electrical



Environmental



Ordering Options



Serial Temperature Sensor

The sensor records the temperature and converts it to an 8-bit digital value. The digital data is then sent to the Analogue Module to be processed. Each Serial Temperature Sensor is supplied with a wall mounting kit and requires no further calibration.

995089

Serial Temperature Sensor



996560PCB&K

Integriti UniBus Analogue Input Expander PCB & Accessories (Includes 270mm UniBus patch cable)
(Due for release late 2018)



Spare UniBus patch cables

- 996791SS - UniBus Patch Cable 150mm
- 996791S - UniBus Patch Cable 220mm
- 996791L - UniBus Patch Cable 270mm
- 996791LL - UniBus Patch Cable 475mm
- 996791XL - UniBus Patch Cable 675mm

The UniBus 8 Relay Auxiliary Expander provides 8 independent, high current normally open or normally closed relay outputs, offering a general purpose interface in applications such as warning devices (strobes, etc.), building automation and process control.

The UniBus 8 Relay Expander is designed for installation within the same tamper-protected enclosure as its UniBus host module. The UniBus device is connected directly to the host module or another UniBus device via the UniBus patch cable supplied.

Host Module Compatibility

The UniBus 8 Relay Expander is compatible with the following UniBus Host Modules:

- Integrati ISC Controller (Part. 996001 series) - Connect up to 4
- Integrati IAC Controller (Part. 996035PCB&K) - Connect up to 4**
- Integrati 8 Zone RS-485 LAN Expander (Part. 996005PCB&K) - Connect up to 4
- Integrati ILAM RS-485 LAN Access Module (Part. 996018PCB&K) - Connect up to 2*

*Relays will mimic the Lock & DOTL outputs on ILAM doors 1-8 (Aux 1~16)

**Relays can be used for general purpose outputs when mapped to Aux 1~16 on IAC, and will mimic the Lock & DOTL outputs on doors 1-8 when mapped to Aux 17~32

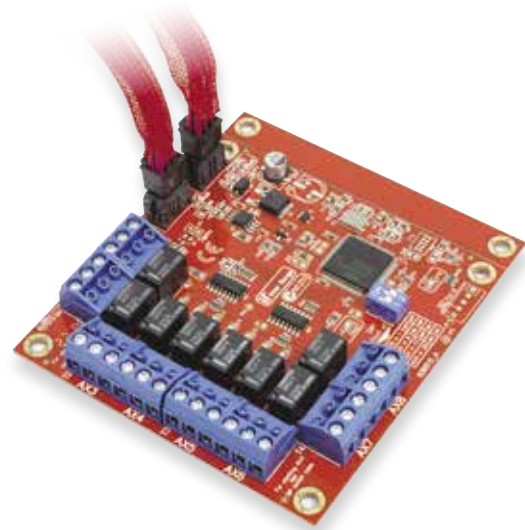

| UniBus Device Compatibility Guide | UniBus Host Module | | | |
|-----------------------------------|--------------------|-----|-----------------|------|
| | ISC | IAC | 8 Zone Expander | ILAM |
| 8 Zone Expander | 2 | 0 | 3 | 0 |
| 8 Relay Expander | 4 | 2 | 4 | 2 |
| 2 Door / 2 Reader Expander | 0 | 3 | 0 | 3 |
| 16 Floor Lift Interface | 6 | 6 | 6 | 6 |
| RS-232/RS-485 UART | 4 | 4 | 0 | 0 |
| Analogue Expander | 4 | 0 | 6 | 0 |

Features

- 8 Universal Relay Outputs
- Normally Open or Normally Closed Outputs per relay
- DIP switch addressable first Auxiliary (Relay) 1, 9, 17 or 25
- UniBus loop-through connectors
- 2 LED status/fault indicators
- Over-The-Wire firmware upgradable
- Integrati "C" size footprint 94 x 94mm
- Can be installed above other "C" size PCBs**
- A Snap off strip is included to allow installation above Integrati "B" size PCBs**

** 35mm standoff kit required - Part Number 999009

Connectivity

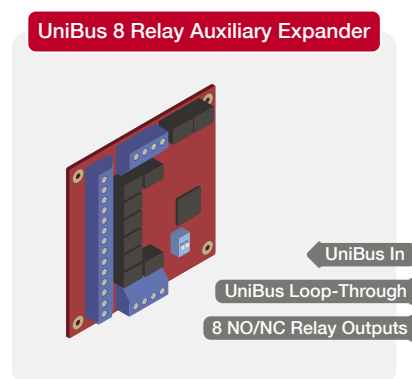

UniBus Installation

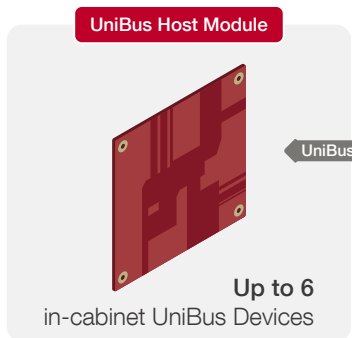

UniBus Devices are designed for installation within the same enclosure as the UniBus host module. A UniBus host can interface a maximum of six UniBus devices in any combination, provided they are all within the intended functionality of the host module

Specifications

Physical

| | |
|------------------------------------|--|
| PCB Size Code: | Integriti "C" size |
| PCB Size: | 94(L) x 94(W) (mm) |
| PCB Size Including Snap Off Strip: | 105(L) x 94(W) (mm) |
| Height: | 15(D) (mm) (28mm with UniBus cable connected) |
| Shipping Weight: | 161 grams |
| Installation Environment: | 0°C - 70°C @15% - 90% Relative humidity (non-condensing) |

Electrical

| | |
|-----------------------------|--|
| Power Supply Input: | 11V to 14V DC via host module |
| Static Current Consumption: | 45mA PLUS 16mA per relay Approximately 175mA when all Relays are on |

Contact Rating

| | |
|----------------------------|--|
| Maximum Switching Current: | 1.0 Amp @ 24VDC or 0.5 Amp @ 50VAC (Per Relay) NOTE: While the relays have higher AC Voltage contact ratings, the manufacturer does not recommend connection of AC voltages above 50VAC to the relay contact connections. |
|----------------------------|--|

Connections

| | |
|----------------------------|--|
| Relay Contacts: | 8 x NO/NC outputs - 24 Connections |
| UniBus Port: | 1 |
| UniBus Loop-through Port: | 1 |
| Connection to Host Module: | Via 270mm UniBus patch lead (supplied) |

Power Considerations

The UniBus host module supplies DET+ current and static device current to all connected UniBus devices.

Total current consumption is, therefore the sum of all:

- Static Current of all connected UniBus devices
- Static Current of host module
- Host module battery charging current
- Ancillary devices connected to all DET+ connections
- Ancillary devices connected to host module's RS-485 LAN+

Compliance

| | |
|---------------|--|
| Electrical | |
| Environmental | |

Ordering Options



996515PCB&K
Integriti UniBus 8 Relay Auxiliary Expander PCB & Accessories (Includes 270mm UniBus patch cable)

Spare UniBus patch cables
9967915S - UniBus Patch Cable 150mm
9967915 - UniBus Patch Cable 220mm
996791L - UniBus Patch Cable 270mm
996791LL - UniBus Patch Cable 475mm
996791XL - UniBus Patch Cable 675mm

The UniBus 2 Port UART provides 2 high speed, software configurable, Serial Ports allowing connection of serial peripheral devices.

Up to 4 UniBus UART devices may be connected to an Integrati Security or Access Controller. DIP switch options allow each Port to be configured for RS-232 or RS-485 operation.

The UniBus 2 Port UART is designed for installation within the same tamper-protected enclosure as its UniBus host module. The UniBus device is connected directly to the host module or another UniBus device via the UniBus patch cable supplied.

Specific RS-232 cables are available separately for the connection of a computer, modem or other serial devices including the Inner Range GSM modem or Multipath IP STU.

Host Module Compatibility

The UniBus 2 Port UART is compatible with the following UniBus Host Modules:

- Integrati ISC Controller (Part. 996001 series) - Connect up to 4
- Integrati IAC Controller (Part. 996035PCB&K) - Connect up to 4

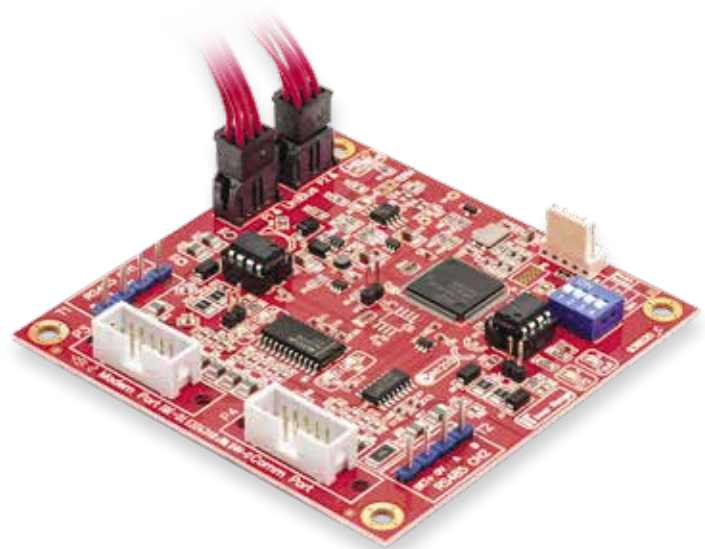

Aiphone GT Series Intercom Integration

Use the UniBus UART to interface to the Integrati - Aiphone GT Series DIN Rail Interface
See page 70 for further details.



IIS (Kenwei) Intercom Integration

Use the UniBus UART to interface directly to the IIS (Kenwei) Apartment Series Intercoms RS-485 LAN for a powerful integrated solution.



| UniBus Device Compatibility Guide | UniBus Host Module | | | |
|-----------------------------------|--------------------|----------|-----------------|----------|
| | ISC | IAC | 8 Zone Expander | ILAM |
| 8 Zone Expander | 2 | 0 | 3 | 0 |
| 8 Relay Expander | 4 | 2 | 4 | 2 |
| 2 Door / 2 Reader Expander | 0 | 3 | 0 | 3 |
| 16 Floor Lift Interface | 6 | 6 | 6 | 6 |
| RS-232/RS-485 UART | 4 | 4 | 0 | 0 |
| Analogue Expander | 4 | 0 | 6 | 0 |

Features

- 2 Software configurable UART Ports
 - Channel 1 - RS-232 Modem / RS-485 Port
 - Channel 2 - RS-232 Comm / RS-485 Port
- DIP switch addressable module number 1, 2, 3 or 4
- DIP switch selectable CH1/CH2 mode, RS-232 or RS-485
- LED indication of CH1 & CH2 RX & TX activity
- LED UniBus status indicator
- 2 LED system status/fault indicators
- UniBus loop-through connectors
- Over-the-wire firmware upgradable
- Integrati "C" size footprint 94 x 94mm
- Can be installed above other "C" size PCBs**
- A Snap off strip is included to allow installation above Integrati "B" size PCBs**

** 35mm standoff kit required - Part Number 999009

Connectivity

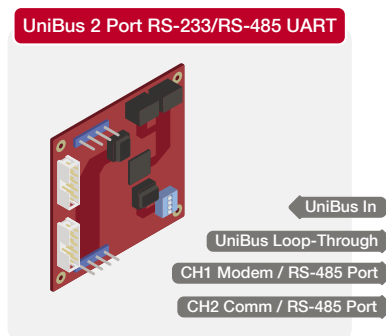

UniBus Installation

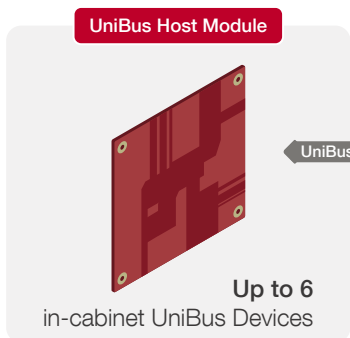

UniBus Devices are designed for installation within the same enclosure as the UniBus host module. A UniBus host can interface a maximum of six UniBus devices in any combination, provided they are all within the intended functionality of the host module

Specifications

Physical

| | |
|------------------------------------|---|
| PCB Size Code: | Integrati "C" size |
| PCB Size: | 94(L) x 94(W) (mm) |
| PCB Size Including Snap Off Strip: | 105(L) x 94(W) (mm) |
| Height: | 15(D)(mm) (28mm with UniBus cable connected) |
| Shipping Weight: | 150gram |
| Installation Environment: | 0°C - 70°C @15% - 90% Relative humidity (non-condensing)) |

Electrical

| | |
|-----------------------------|-------------------------------|
| Power Supply Input: | 11V to 14V DC via host module |
| Static Current Consumption: | 40mA PLUS 5mA per active port |

Connections

| | |
|----------------------------|--|
| Port 1: | CH1 Modem Port or RS-485 |
| Port 2: | CH2 Comm Port or RS-485 |
| UniBus Loop-through Port: | 1 |
| Connection to Host Module: | Via 270mm UniBus patch lead (supplied) |

Communications Formats

| | |
|-----------------|--|
| Port 1 (Modem): | Supports any Comms Task format that requires UART Serial Port communications, including all "Modem" Comms Task formats. |
| Port 2 (Comm): | Supports the Comms Task formats that utilize TXD/RXD and CTS/RTS for UART Serial Port communications. <i>"E Modem" and any formats that require CD, DSR, DTR or RI signals are not supported. Use Port 1 for these formats.</i> |

Power Considerations

The UniBus host module supplies DET+ current and static device current to all connected UniBus devices.

Total current consumption is, therefore the sum of all:

- Static Current of all connected UniBus devices
- Static Current of host module
- Host module battery charging current
- Ancillary devices connected to all DET+ connections
- Ancillary devices connected to host module's RS-485 LAN+

Compliance

| | |
|---------------|-------------|
| Electrical | |
| Environmental | RoHS |

Ordering Options



996520PCB&K
Integrati UniBus 2 Port RS-232/RS-485 UART PCB & Accessories (Includes 270mm UniBus patch cable)



Spare UniBus patch cables
9967915S - UniBus Patch Cable 150mm
996791S - UniBus Patch Cable 220mm
996791L - UniBus Patch Cable 270mm
996791LL - UniBus Patch Cable 475mm
996791XL - UniBus Patch Cable 675mm



Serial Port Patch Cables
993009 - Computer interface cable (DB9)
993026 - Serial Printer interface cable (DB25)
993027 - Modem interface cable (DB25)
993035 - Securitel interface cable (Flying leads)
995009 - Internal PC Interface cable kit.

Installed inside the cabinet to the DB9 knockout, to provide an external DB9 serial connection.

The UniBus 16-Floor Lift Interface Device provides an efficient integration between the Integrati Security System and a lift system. This facilitates managed and secure floor access for users within multi-story buildings and apartment blocks. The UniBus Lift Interface device utilises a low-level button feedback interface between Integrati and the lift system. It incorporates input conditioning and switching to provide the isolation required between the two systems.

Using an Integrati UniBus cable, the device connects directly to the Integrati host module or via another UniBus device.

Up to 6 UniBus 16-Floor Lift Interface devices can be connected to a single host module to provide access control for a single lift car servicing up to 96 floors. (Multiple lift cars require multiple host modules)

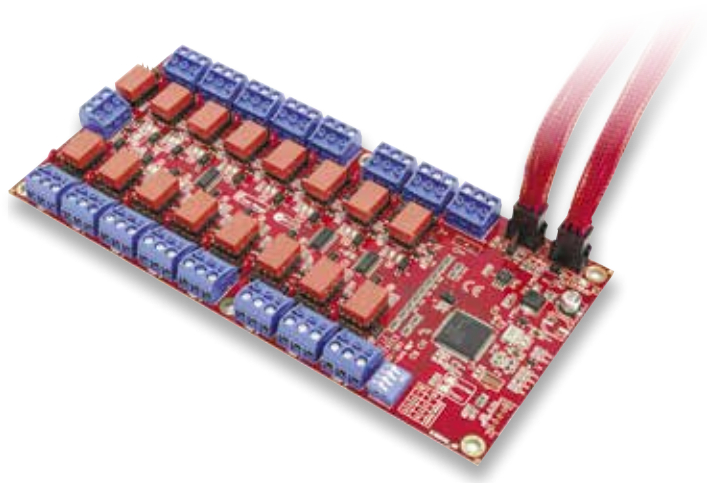

| UniBus Device Compatibility Guide | UniBus Host Module | | | |
|-----------------------------------|--------------------|----------|-----------------|----------|
| | ISC | IAC | 8 Zone Expander | ILAM |
| 8 Zone Expander | 2 | 0 | 3 | 0 |
| 8 Relay Expander | 4 | 2 | 4 | 2 |
| 2 Door / 2 Reader Expander | 0 | 3 | 0 | 3 |
| 16 Floor Lift Interface | 6 | 6 | 6 | 6 |
| RS-232/RS-485 UART | 4 | 4 | 0 | 0 |
| Analogue Expander | 4 | 0 | 6 | 0 |

Features

- Low level with button feedback UniBus connectivity
- Compatible with a range of Integrati host modules
- Manage 16 floors per device
- Connect up to 6 devices per Integrati host module
- Wide range of button input voltages
- Button sense input per floor
- Override input to allow free access mode
- Isolation between lift and Integrati system
- Firmware upgrades over-the-wire

Connectivity

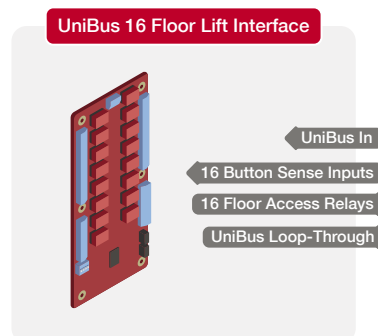

UniBus Installation

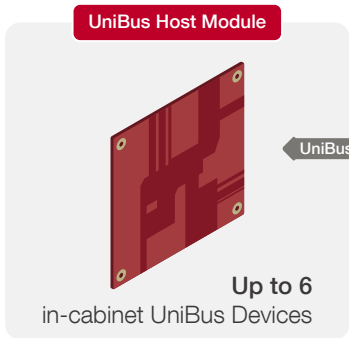

UniBus Devices are designed for installation within the same enclosure as the UniBus host module. A UniBus host can interface a maximum of six UniBus devices in any combination, provided they are all within the intended functionality of the host module

Specifications

Physical

| | |
|---------------------------|--|
| PCB Size Code: | Integrati "B" size |
| PCB Size: | 200(L) x 94(W) (mm) |
| Height: | 15(D) (mm) (28mm with UniBus cable connected) |
| Shipping Weight: | 300grams |
| Installation Environment: | 0°C - 70°C @15% - 90% Relative humidity (non-condensing) |

Electrical

| | |
|-----------------------------|--|
| Power Supply Input: | 11V to 14V DC via host module |
| Static Current Consumption: | 55mA PLUS 16mA per relay. Approximately 310mA when all relays are on |

Contact Rating

| | |
|----------------------------|--|
| Maximum Switching Current: | 500mA @ 16 – 48V DC/AC RMS 200mA @ 60 – 110V DC/AC RMS (30W / 62.5VA) 50VAC |
|----------------------------|--|

Connections

| | |
|----------------------------|--|
| Relay Contacts: | 16 x NC outputs |
| Override Input: | 1 |
| Button Sense Inputs: | 16 |
| UniBus Port: | 1 |
| UniBus Loop-Through Port: | 1 |
| Connection to Host Module: | Via 270mm UniBus patch lead (supplied) |

Compliance

| | |
|---------------|--|
| Electrical | |
| Environmental | |

Ordering Options



996540PCB&K
Integrati UniBus 16 Floor Lift Interface device PCB & Accessories (Includes 270mm UniBus patch cable)

Spare UniBus patch cables
9967915S - UniBus Patch Cable 150mm
9967915 - UniBus Patch Cable 220mm
996791L - UniBus Patch Cable 270mm
996791LL - UniBus Patch Cable 475mm
996791XL - UniBus Patch Cable 675mm

eliteX KEYPAD

The EliteX OLED keypad is elegantly designed and features a clear and easy to read OLED display. Users can use the keypad to perform typical operations on the Integrati system. This includes control of security areas, door access, event activity review and controlling the state of outputs.

Users PIN numbers can also be changed directly from the keypad. The OLED display shows plain text navigation through operations and alarms, events and items are presented by name.

The keypad's 8 indicator LEDs can also display the real-time status of the security system.

For the Installer, EliteX can be used to program the entire Integrati system. (Macros excluded). This allows the installer to make quick and efficient changes as needed without need to access the Integrati software. The EliteX supports 12 Languages.

SIFER Reader option for EliteX.

A plug-on SIFER Reader kit is available for the EliteX Keypad. With this option fitted the keypad can be used as a reader for access control on doors or for high security "Card & PIN" dual credential authentication for login access to the Keypads menus.

Features

- Clear and easy to read 2-Line OLED display
- Programmable backlight brightness suitable for bright or low-light environments
- Slimline surface mount design
- Stylish design and neutral colours will look great in any environment
- Design style compliments the PrismaX Keypad (colour screen model)
- Backlit rubberised keypad provides a user-friendly tactile feel
- Eight LEDs provide area status, door functions, alarms and other conditions via programming options
- Instant help text available anytime, at the press of a key
- Multilingual firmware as standard (12 languages)
- Four arrow keys provide quick and convenient access to menu options
- Zone inputs and auxiliary outputs provided for connection of local I/O devices
- Programmable panic key and duress option
- Built-in module locator buzzer
- Tamper monitored housing
- Compatible with Integrati, Inception & Concept 4000 Systems

Features with SIFER Reader kit fitted

- Support for all SIFER credentials
- Support for 13.56Mhz cards(CSN Only)
- Support for Card access control
- Support for Card & PIN access control
- Support for Card only terminal login
- Support for Card & PIN terminal login

Connectivity

The EliteX Keypad is connected directly to the Integrati RS-485 LAN. Up to 99 Keypads may be installed per Integrati Controller.

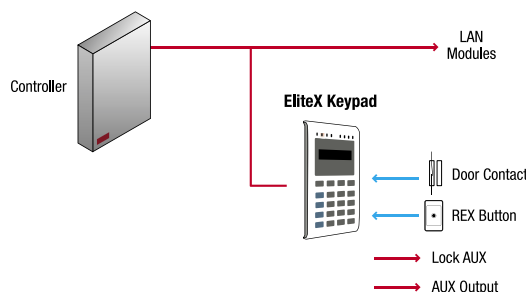

Specifications

Physical

| | |
|---------------------------|---|
| Housing Dimensions: | 168(H) x 88(W) x 19(D) (mm) |
| Installation Environment: | 0° - 50°C @ 15% to 85% relative humidity (non-condensing) |

Electrical

| | |
|--|--|
| Input Voltage: | 11V – 14V DC |
| Operational Current: | 14.4mA (Back-light & LEDS off), 42mA (Back-light & LEDS max brightness) |
| Operating Current with SIFER PCB: | 46mA (Back-light & LEDS off), 186mA (Peak, Back-light & LEDS max brightness) |
| Auxiliary Open Collector Output Current: | 18VDC, 500mA maximum each (PTC protected) |

Display & Indicator Brightness

| | |
|------------------|---|
| Display/ Keypad: | Variable brightness via programming (Can be turned off) |
| LED Indicators: | Variable brightness via programming |

Indicators & I/O's

| | |
|-------------------------------|---|
| LED Indicators: | 8 |
| Aux Outputs (Open collector): | 2 |
| Universal I/O's: | 2 (Input mode is compatible with original Elite, or EOL/Multi-state compatible) |

Compliance

| | |
|---------------|--|
| Electrical | |
| Environmental | |



Ordering Options

995400
EliteX Keypad

994721PCB&K
Plug-on SIFER Reader kit to suit EliteX or PrismaX Keypads

999059X
Security shroud to suit PrismaX/EliteX Keypad



prismaX KEYPAD X

Sharing the same attractive design style as the EliteX, the PrismaX Keypad boasts a full-colour LCD display. End-users will delight in using the PrismaX keypad, with large clear text and icon-driven menus control of the Integrati system is made simple.

Just some of the functions supported include monitoring and acknowledging alarms and events, arming/disarming, unlocking/locking doors, controlling automation functions and isolating zones. Eight dual colour status LEDs can be used to display the armed/disarmed state of areas or for other intruder, access control or automation purposes. An in-built temperature sensor displays the room temperature and can also be integrated into the system for building automation control.

SIFER Reader option for PrismaX

A plug-on SIFER Reader kit is available for the PrismaX Keypad. With this option fitted the keypad can be used as a reader for access control on doors or for high security "Card & PIN" dual credential authentication for login access to the Keypads menus.

Please note: The PrismaX Keypad is designed as an end user interface for the Integrati system and as such only the end user related menus are supported. Where access to installation and commissioning menus is required the EliteX Keypad is recommended.



Features

- Elegant slimline surface mount design
- Full colour LCD backlit screen
- Large – easy to read text
- Four arrow keys provide quick and convenient access to options in the graphic interface menu
- Tamper monitored housing
- Light sensitive auto-dimming brightness for LCD, Keypad and LED's
- Backlit rubberised keypad provides a user-friendly tactile feel
- Local temperature display
- 8 LED indicators for Area status display
- Instant help text available anytime, at the press of a key
- Programmable panic key and duress option
- Compatible with Integrati Systems only

Features with SIFER Reader board fitted

- Support for all SIFER credentials
- Support for 13.56Mhz cards(CSN Only)
- Support for Card access control
- Support for Card & PIN access control
- Support for Card only terminal login
- Support for Card & PIN terminal login

Connectivity

The PrismaX Keypad is connected directly to the Integrati RS-485 LAN. Up to 99 Keypads may be installed per Integrati Controller.

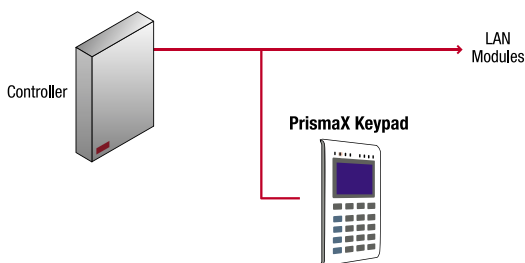

Ordering Options



996400
Integrati PrismaX Keypad

994721PCB&K
Plug-on SIFER Reader kit to suit PrismaX or EliteX Keypads



999059X
Security shroud to suit PrismaX/EliteX Keypad

Specifications

Physical

| | |
|---------------------------|---|
| Housing Dimensions: | 168(H) x 88(W) x 19(D) (mm) |
| Installation Environment: | 0° - 50°C @ 15% to 85% relative humidity (non-condensing) |

Electrical

| | |
|-----------------------------------|---|
| Input Voltage: | 11V – 14V DC |
| Operational Current : | Auto current limiting typically less than 100mA @12V (270mA Peak) |
| Operating Current with SIFER PCB: | Auto current limiting typically less than 100mA @12V (300mA Peak) |

Indicators

| | |
|-----------------|--|
| Speaker: | 8-bit digital sound |
| LED Indicators: | Array of 8, Auto-dimming bi-colour LED |

User Interface

| | |
|-------------------|---|
| LCD Screen: | 320 x 240 (QVGA) colour LCD |
| LCD Backlight: | Variable brightness via programming, Auto-dimming (Can be turned off) |
| Keypad Backlight: | Variable brightness via programming, Auto-dimming (Can be turned off) |

System Outputs

| | |
|-----------------|---|
| LED Indicators: | 8 |
| Beeper/Speaker: | 1 |

Compliance

Electrical



Environmental



The Weatherproof Keypad sports an incredibly robust design that is dust proof and highly water resistant. Rated to IP65, the solid aluminium case is stylish and vandal resistant.

Perfect for gate or door access control where the Keypad will be exposed to the environment. In addition to the single door/gate access control, users may also separately arm/disarm their alarm system or just their tenancy. Visible feedback of "valid/invalid PIN" and "area armed/disarmed status" is provided through the LEDs.

This wholly Inner Range solution does not require special user configuration (unlike previous solutions using third party products). All users have access to PIN code functionality, similar to that of a normal EliteX or PrismaX Keypad, but restricted to the connected door/area associated with the Keypad or user.



Features

Keypad

- Attractive, rugged case is highly vandal resistant
- Completely dust proof and highly water resistant IP65 rated case with no moving parts
- Control one door per keypad
- Control a security area associated with the door or user's special area
- Piezo effect push buttons with audible feedback
- Easy to install
- Displays login status and area status with "Code" and "Armed" LEDs
- Keypad lockout feature if >3 or 10 incorrect logins in a row
- Extendable flying leads provide option to house Reader Module in more sheltered location.

Reader Module PCB

- Provides reed and tongue sense monitoring
- Request to Enter (REN) and Request to Exit (REX) inputs provided
- On-board lock relay
- Fuse protection of keypad power

Specifications

Physical

| | |
|----------------------------------|---|
| Keypad Dimensions: | 120(L) x 65(W) x 27(D) (mm) |
| Keypad Installation Environment: | -30° to +60° Celsius and 0 to 95% relative humidity (non-condensing). IP65 Moisture & Dust rating |
| PCB Dimensions: | 95(L) x 95(W) (mm) |
| PCB Installation Environment: | 0° – 50°C @ 15% to 85% Relative humidity (non-condensing) |

Electrical

| | |
|-----------------------|---|
| Input Voltage to PCB: | 11-14VDC (Typically from separate power supply) |
| Operational Current: | Standby: 40mA |
| | Logged on: 45 to 55mA |
| | With lock relay active: 72mA |
| | All Auxiliaries active: 180mA |
| Fuse Protection: | 500mA (Keypad/Reader power) |

Inputs

| | |
|---------------|---|
| Zone Inputs: | 5 (May have predefined functions depending on programming options selected, i.e.: Door Reed, REX, REN, Tongue Sense and Arm button) |
| Reader Ports: | 1 (used for keypad) |

Outputs

| | |
|---------------------------|---|
| Relay: | 1 (Typically used for door lock) |
| Outputs (Open Collector): | 5 (3 reserved for Valid/Invalid, Area Armed/Disarmed indication, keypad beeper) |

Connectivity

The Weatherproof Keypad is connected to the Controller RS-485 LAN through the supplied Reader Module.

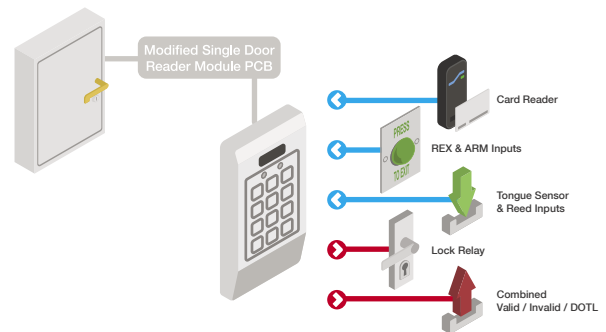

Ordering Options



995010

Weatherproof Keypad (short form kit containing keypad and reader module PCB. Requires external power supply).

995010PCB&K

Weatherproof Keypad PCB (supplied with PCB only)

The Inner Range - Paradox RF module is a cost-effective wireless RF solution that allows Paradox Magellan Wireless PIR's, reed switches, smoke detectors and remote control fobs to function on the Integrati or Concept Systems. Wireless functionality is added to the Inner Range Controller with the inclusion of Paradox Magellan wireless devices, with each Paradox Expander Module supporting 32 wireless detection zones (PIR's, reed switches and smoke detectors). The interface supports monitoring low battery alarms for all wireless devices.

The Paradox REM2 and REM3 remote control fobs provide bi-directional audible and visual feedback when arming or disarming the system and when controlling output auxiliaries. In addition to this, the REM 2 & 3 remotes feature an information button which can be used to indicate the current status of the security area.

All fobs feature buttons which can be programmed to provide different actions and four or six digit wireless PIN verification is also provided when using the REM3 remote control unit.

Paradox wireless devices:

- Remote Controls & Fobs
- Motion Detectors
- Wireless Door Contacts (Reed Switches)

Features

- The Paradox RF Expander connects directly to the Integrati or Concept RS-485LAN
- Each expander will provide up to 32 wireless detection zones
- Cost effective RF Wireless Solution
- Fully compatible with selected Paradox Magellan wireless devices, Detectors, Door Contacts, RF Fobs and Smoke Detectors
- Bi-directional wireless audible & visual feedback on selected RF Fobs for area arming/disarming and output control
- Wireless PIN entry using selected models of RF Fobs
- Low Battery supervision & reporting from all wireless devices
- Wireless panic input

Specifications

Physical

| | |
|---------------------------|---|
| Enclosure Dimensions: | 150(L) x 166(W) x 32(D) (mm) (Not including antennae) |
| Installation Environment: | 0° - 50°C @ 15% to 85% Relative humidity (non-condensing) |

Electrical

| | |
|----------------|---|
| Input Voltage: | PCB 11-14VDC (operational current 65mA) |
| Zone Inputs: | 32 wireless zones |
| Key Fobs: | 1 per user in Integrati Limit of 100 Fobs in Concept depending memory configuration |

System Inputs

| | |
|--------------------|--|
| System Inputs: | Transmitter Low Battery, Transmitter Poll Fail and RF Jam, Cabinet Tamper, Module Low Volts, LAN Fail and Module Low Battery |
| RF Frequency Band: | RF Frequency 433.92 or 868MHz Switchable |

Compatibility

| | |
|-------------------------|-------------------------|
| PIR's: | PMD1P, PMD75, PMD85 |
| Wireless Door Contacts: | DCT10, DCTXP2, DCT2 |
| Remote Control FOBS: | REM1, REM15, REM2, REM3 |
| Asset Protector: | GS250 |
| Panic Pendant: | REM101 |
| Smoke Detectors: | SD738 |



Connectivity

The RF expander is connected directly to the Controller RS-485 LAN. (Check memory allocations for module quantity with Concept Systems)

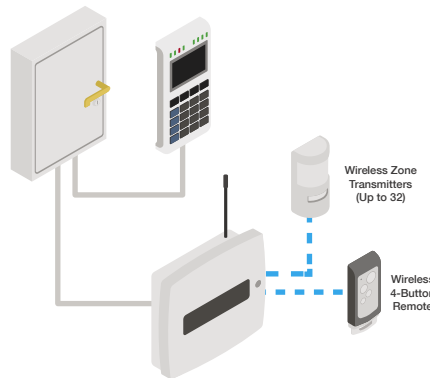

Ordering Options



995025
RF Module Paradox (433/868 Mhz)

The Inner Range - Inovonics™ RF Expander is an RS-485 LAN based module which provides an interface for Inovonics™ EchoStream wireless security transmitters such as detectors, universal transmitters and user pendants.

Up to 32 detectors can be monitored by each Module. User pendant transmissions can be received via any RF Expander Module in the system.

The range of an RF system can be expanded by using Inovonics™ Repeater units which allow RF signals to be forwarded onto the Expander Module.

User pendants and security transmitters can be easily registered into the Integrati system.



Features

- The Inovonics RF Expander connects directly to the Integrati or Inception RS-485 LAN
- Each Expander will provide up to 32 wireless detection zones
- Low Battery supervision & reporting from all wireless devices
- Frequency selectable to suit AU/NZ RF bands
- PCB only kit option available (for Europe only)
- World-renowned high quality RF wireless solution
- Fully compatible with Inovonics security range of transmitter devices including:
 - Body Worn Pendant Transmitters
 - Fixed Position Hold Up Pendant Transmitters
 - Universal Transmitters - Reed Switches/Contacts
 - Smoke Detectors
 - Glassbreak Detectors
 - PIR Motion Detectors
 - High Power Repeaters
- See the Inovonics Security Product Guide Australia / New Zealand for further details

Connectivity

The RF expander is connected directly to the Controller RS-485 LAN.

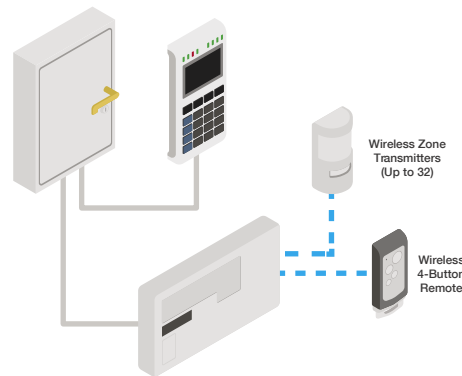

Specifications

Physical

| | |
|---------------------------|---|
| Enclosure Dimensions: | 165(L) x 92(W) x 28(D) (mm) |
| Installation Environment: | 0° - 50°C @ 15% to 85% Relative humidity (non-condensing) |

Electrical

| | |
|----------------|---|
| Input Voltage: | PCB 11.5-14VDC (operational current 115mA) |
| Zone Inputs: | 32 wireless zones |
| Key Fobs: | 1 per user, only limited by user quantity available in controller |

Inputs

| | |
|--|--|
| | Transmitter Low Battery, Transmitter Poll Fail and RF Jam, Cabinet Tamper, Module Low Volts, LAN Fail and Module Low Battery |
|--|--|

Compatibility

| | |
|--|--|
| | Compatible with Integrati ISC/ IAC Controllers and Inception Controllers |
|--|--|

Frequency Bands

| | |
|--------------|-------------|
| Australia: | 915-928 MHz |
| New Zealand: | 921-928 MHz |

Ordering Options



996008
Inovonics RF Module (AU & NZ Only)

The Aiphone - Integrati Interface module is a small (2-Pole) DIN rail mount device which allows Integrati to receive events from Aiphone GT series intercom systems.

The module provides the communication link between the Aiphone 2 wire bus and the Integrati RS-485 UART port and allows Integrati to monitor events from lobby entrance and apartment based intercom stations.

Where visitor access is granted by way of pressing the unlock button on the apartment intercom station, Integrati can listen to that request from the Aiphone system and subsequently unlock a door and/or provide the visitor with lift access to the appropriate floor.



Features

- Provides Integration between Aiphone GT series intercoms and the Integrati Access Control system
- Allows Integrati to unlock doors and/or provide lift/floor access for visitors based on intercom events
- Support for up to 250 apartment intercom stations
- Support for up to 4 lift cars
- Optically isolated communications
- Small DIN rail mount 2-Pole enclosure
- Can be installed alongside the DIN rail mounted Aiphone Intercom system
- Compatible with Aiphone GT series 2-wire intercom systems

Connectivity

The Integrati Aiphone Interface is connected to the Integrati Unibus UART RS-485 port and the Aiphone 2-wire Bus

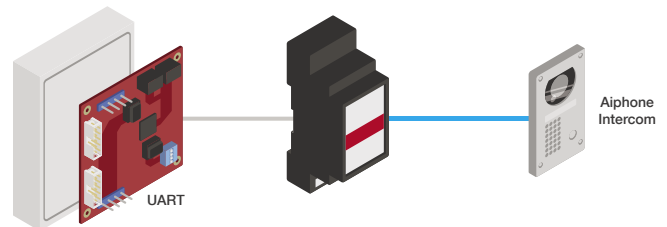

Specifications

Physical

| | |
|---------------------------|---|
| Enclosure Dimensions: | 88(L) x 37(W) x 59(D) (mm) (2-Pole DIN) |
| DIN Rail Compatibility: | 35mm DIN rail |
| Installation Environment: | 0° - 50°C @ 15% to 85% Relative humidity (non-condensing) |

Electrical

| | |
|--------------------------|--|
| Input Voltage Integrati: | Integrati UART RS-485 Port 11.5-14VDC, 7mA |
| Input Voltage Aiphone: | Aiphone 2-wire LAN 24VDC, 3.2mA |

Communications

| | |
|-------------------------------|--|
| Integrati UART Configuration: | 9600 Baud, 8 data bits, 1 Stop bit, Odd parity |
|-------------------------------|--|

Compatibility

| | |
|---------------|--|
| Electrical | |
| Environmental | |

Ordering Options



994210
Aiphone - Integrati Interface Module

Designed as a cost-effective and space-saving single door module, this device is perfect for organisations that only require a small number of access control doors or where installation space is a premium.

The Single Door Access Module supports one door, one Wiegand card reader and the required inputs and outputs for the control and monitoring of a single door. A single auxiliary output is provided for use as a general purpose output or to control reader LEDs and/or buzzers, indicate "Door Open Too Long" (DOTL), or used for "Valid/Invalid" feedback.

Configuration options allow for a broad range of card reader technologies and support is provided for multiple card reader formats.

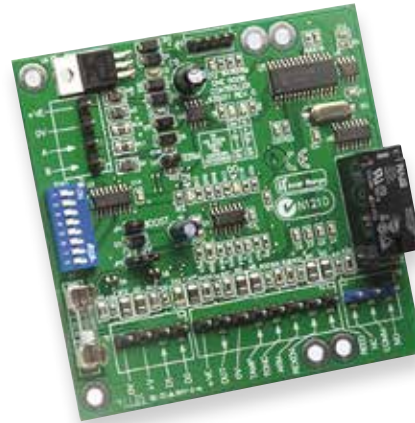

Features

- Supports magnetic swipe or Wiegand card readers without the need for an additional interface
- Standard version supports offline database of up to 31 backup cards
- Provides reed and tongue sense monitoring
- Request to Enter (REN), Request to Exit (REX) & Arm inputs provided
- Door Open Too Long (DOTL), valid and invalid output
- On-board lock relay
- Fuse protection of reader power

Connectivity

The 1 Door Access Module is connected directly to the Controller RS-485 LAN. (Check memory allocations for module quantity with Concept Systems)

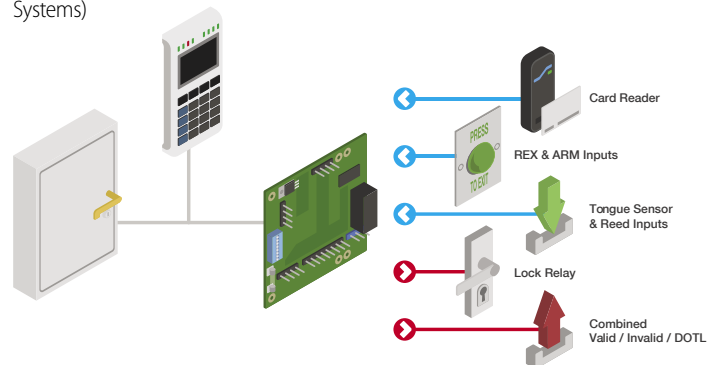

Specifications

Physical

| | |
|---------------------------|---|
| PCB Dimensions: | 95(L) x 95(W) (mm) |
| Installation Environment: | 0°C - 50°C @15 - 85% Relative humidity (non-condensing) |

Electrical

| | |
|-----------------------|--|
| Input Voltage to PCB: | 11-14VDC (Typically from separate power supply) |
| Operational Current: | 15mA |
| Max: | 25mA with lock relay active. (NOT including Reader or Auxiliary Out current) |
| Fuse Protection: | 500mA |

Connections

| | |
|-------------------------------------|--|
| Zone Inputs: | 4 (May have predefined functions depending on programming options selected, i.e.: Door Reed, REX/REN, Tongue Sense and Arm button) |
| Reader Ports: | 1 |
| Outputs: | Relay 1 (Typically used for door locks) |
| Auxiliary Outputs (open collector): | 1 (Typically used for Valid/Invalid indication) |

Ordering Options



995011PCB&K
1 Door Access Module

The Analogue Module provides the capability to monitor, report and action on analogue values within an Integriti or Concept system. This module can be programmed to operate an auxiliary when an analogue level from one or more of its independent analogue inputs exceeds or goes below a pre-programmed trigger point. Analogue levels can be monitored and controlled in scaled units through the Integriti software or at any EliteX Terminal.

The Analogue Module allows the programmer a variety of selectable mode settings and levels with which to configure the system to the particular application. The trigger point, output auxiliary, tamper levels and hysteresis values may be individually selected for each input.

The Analogue Modules requires firmware 5.20 or later for Integriti compatibility.

Features

- Four independent analogue inputs, each with its own programmable 'trigger point'
- 0-5V or 4-20mA types available • 8-bit resolution, 1% accuracy
- Compatible with the Serial Temperature Sensor (995089)
- LAN voltage monitoring
- Cabinet tamper input • Four output auxiliaries
- Two general purpose digital inputs (no EOL resistors)

Specifications

Physical

| | |
|-----------------------------------|--|
| Cabinet Dimensions: | 305(L) x 140(W) x 72(D) (mm) |
| PCB Dimensions: | 140(L) x 95(W) (mm) |
| Installation Environment: | 0°C - 50°C @15 - 85% Relative humidity (non-condensing) |
| Cabinet Dimensions (Temp Sensor): | 116(L) x 77(W) x 14(D) (mm) |

Electrical

| | |
|-------------------------------------|--------------------------------------|
| Input Voltage to PCB: | 11-14VDC |
| Operational Current: | ~30mA |
| Input Voltage to PCB (Temp Sensor): | 5VDC (1mA) from host Analogue Module |

Inputs

| | |
|------------------------------|---|
| Zone Inputs: | 4 Analogue inputs, 2 general purpose zone Inputs |
| Input Range: Voltage Option: | 0-5VDC uni-polar referenced to 0V input terminal |
| Current Loop Option: | 4-20mA DC polarised, input termination resistor selectable |
| Input Impedance: | 10kOhm set by input termination resistor. (ADC Input Impedance~10MOhm) |
| ADC Resolution: | 8bit |
| Input Resolution: | 20mV |
| Over Voltage Protection: | Yes |
| ESD Protection: | Yes |

Outputs

| | |
|-------------------------------------|--|
| Outputs (open collector): | 4 |
| Max. Switchable Current per output: | 200mA |
| Max. Combined Output Current: | To be included within the constraints of the power supply source |

Sensor Specification

| | |
|----------------------------------|--|
| Temperature Range (Temp Sensor): | 0°C - 125°C or -55°C - +70°C Resolution +/- 0.5°C |
|----------------------------------|--|

Accuracy

| | |
|---------------------|--|
| Temperature Sensor: | 0°C - 70°C +/- 0.5°C, 70°C - 85°C +/- 1.0°C, 85°C - 125°C +/- 2.0°C |
|---------------------|--|



Connectivity

The Analogue Module is connected directly to the Integriti/Concept RS-485 LAN. (Check memory allocations for module quantity with Concept Systems).

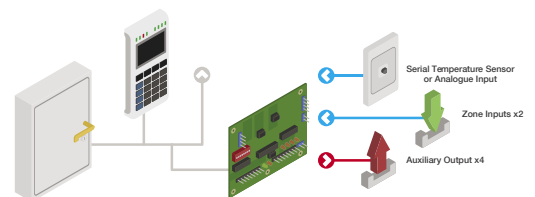

Ordering Options

- 995088**
Analogue Module (Voltage Mode) in metal enclosure
- 995088C**
Analogue Module (Current Mode) in metal enclosure



- 995088PCB&K**
Analogue Module (Voltage Mode). Short form kit



Serial Temperature Sensor

The sensor records the temperature and converts it to an 8-bit digital value. The digital data is then sent to the Analogue Module to be processed. Each Serial Temperature Sensor is supplied with a wall mounting kit and requires no further calibration.



- 995089**
Serial Temperature Sensor

The LAN Ethernet Bridge provides a secure, isolated connection of physically separate RS485 LAN segments over an Ethernet network for Inception, Integrati and Infniti systems. The electrical isolation achieved between the LAN segments also eliminates the potential for earth loops.

The LAN Ethernet Bridge is Installer configurable and employs 128-bit AES encryption for secure Ethernet communications. It enrolls on the LAN as an RS485 LAN Module allowing status monitoring and reporting.

One or more LAN Ethernet Bridges are installed in remote locations to provide an interface between an Ethernet network and the local RS485 LAN segment. The Ethernet network provides the communication path between the Controller's on-board Ethernet Port and the LAN Ethernet Bridge. An Ethernet Bridge is not required at the Controller end.



Features

- Compatible with Infniti, Integrati and Inception
- Does not require a master / slave configuration – Ethernet Bridge Module communicates directly with Controller
- Up to 30 Ethernet Bridge Modules per Controller
- Up to 30 RS-485 LAN modules downstream from Ethernet Bridge Module
- Allows TCP or UDP connections
- RS-485 expansion via IP infrastructure
 - Use existing IP Networks to save wiring time & costs
 - Allows for flexible system design
- Remote configuration via Ethernet LAN Configuration Tool
- Over-The-Wire firmware upgradeable
- AES 128-Bit Encryption
- External Integrati power supply connection
- Full monitoring of external Integrati SMART power supply
- Dedicated cabinet tamper input

Connectivity

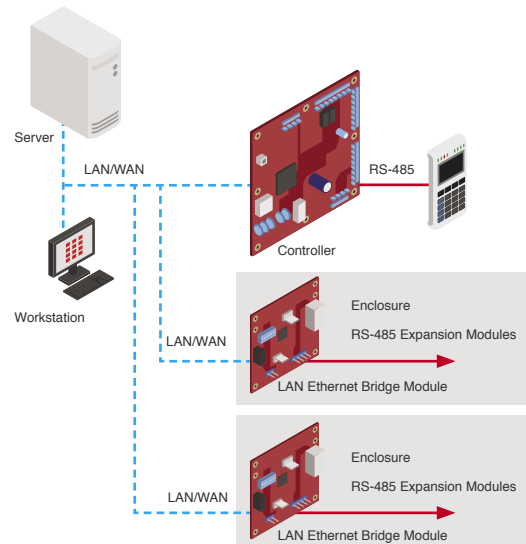

Specifications

Physical

| | |
|---------------------------|--|
| PCB Dimensions: | 105 (L) x 94(W) x 18(H) (mm) |
| Installation Environment: | 0° to 49° Celsius (32° to 120° F) 15% to 85% Relative humidity (non-condensing) |

Electrical

| | |
|-----------------------|----------|
| Input Voltage to PCB: | 11-14VDC |
| Operational Current: | 60mA |

Cabling

| | |
|-----------------|--|
| Ethernet Port: | As per standard 10/100MHz Ethernet cabling specifications. |
| RS485 LAN Port: | As per Integrati/Inception LAN cabling specifications. |

Minimum Firmware / Software Versions

| | |
|-------------------------------------|-----------------|
| Integrati/Infniti ISC/IAC Firmware: | V20.1 or later. |
| Integrati/Infniti Software: | V20.1 or later. |
| Inception Firmware: | V4.0 or later. |

Compliance

| | |
|----------------|--|
| Electrical: | |
| Environmental: | |

Module Limitations

The number of LAN modules a Controller can support via LAN Ethernet Bridges is limited depending on the types of modules being deployed, and the Ethernet Protocol being used (TCP or UDP). Refer module limitations table below:

| Module Type | TCP | UDP |
|---|-----|-----|
| Intruder Alarm Only | 90 | 135 |
| Simple Access Control or Integrated System | 60 | 90 |
| Access Control System with Intelligent LAN Access Modules | 30 | 45 |

More details on module limitations can be found in the LAN Ethernet Bridge installation manual.

Ordering Options

996088
Ethernet Bridge Module



The LAN over Ethernet Interface (CLOE) provides a convenient interface for the Integrati or Concept RS-485 LAN to be distributed over standard TCP/IP Ethernet networks.

Ethernet connectivity allows the RS-485 LAN to operate over an IP network architecture including 802.3i (10baseT) and 802.3U (100baseT) switching and routing equipment. Wireless communications can also be achieved using a wireless router and Ethernet / 802.11 point to point RF solutions.

CLOE provides the full flexibility of Ethernet networks while maintaining the high security and scale of the standard RS-485 LAN architecture.

The CLOE system supports the TCP/IP protocol with all data encrypted using 128 bit AES encryption. Security is monitored in all RS-485 segments of the LAN providing alarms for network outages or module substitution conditions.

Every CLOE module can be assigned as a master or a slave via initial setup options and the master unit is configured with a static IP address while the slave units support static or dynamic addressing. The use of Ethernet networks also provides the added benefit of electrical isolation between RS-485 LAN segments.

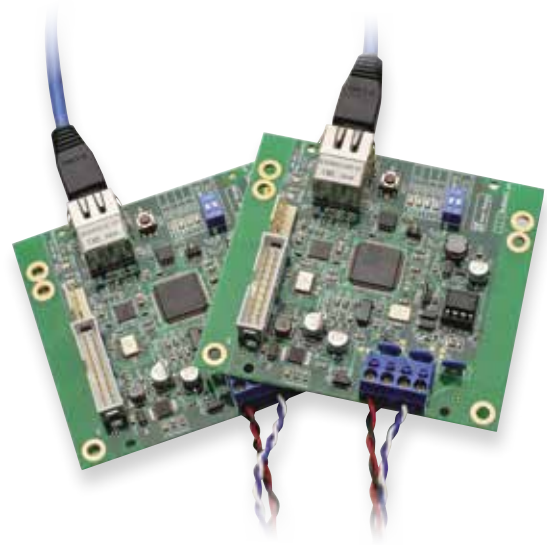

Features

- Compatible with Integrati, Inception or Concept 4000 RS-485 LAN
- Transmit the RS-485 LAN over Ethernet Networks
- Convert Standard RS-485 LAN Modules into Ethernet LAN Modules
- Serial communication speeds of up to 19200 baud
- Extend the Integrati, Inception or Concept 4000 LAN distance
- Use wireless IP technologies to save wiring costs
- Use existing IP Networks to save wiring time & costs
- Deploy single Control Modules across multiple sites
- Provide electrical isolation between RS-485 LAN segments
- AES 128 bit encryption

Connectivity

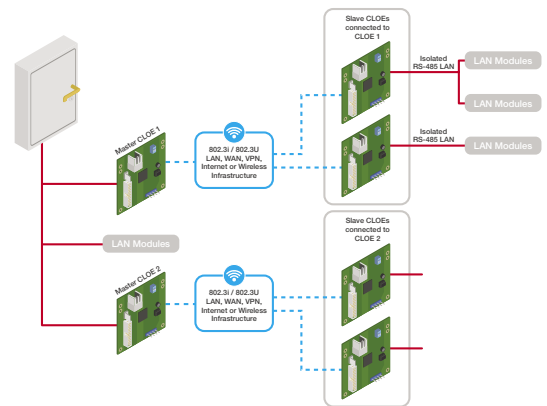

Specifications

Physical

| | |
|---------------------------|--|
| PCB Dimensions: | 95(L) x 95(W) (mm) |
| Installation Environment: | 0°C-50°C @ 15% to 85% Relative humidity (non-condensing) |

Electrical

| | |
|-----------------------|--------------------------------------|
| Input Voltage to PCB: | (11-14VDC) |
| Operational Current: | Typical: ~65 mA Max: 110mA |
| Ethernet LAN: | 10baseT / 100baseT (802.3i / 802.3U) |
| Ethernet Connector: | RJ45 |

Ordering Options



995093
LAN Over Ethernet Module

The Inner Range Fibre Modem provides two separate, optically isolated ports to the Integriti, Inception or Concept system LAN. A set of Fibre Modems is ideal for applications where modules are separated in different buildings and/or are separated by large distances.

In terms of an Integriti, Inception or Concept system, Fibre Modem links boost maximum LAN distance while providing immunity to earth loops, induced electrical noise and propagation of pulses from lightning strikes by virtue of the optical isolation.

The modems have two fibre ports which enable sets of Fibre Modems to be arranged in 'branch' or 'loop' configurations. Each fibre port utilises a pair of fibres per link to provide full-duplex communication. Up to 5 Fibre Modems can be connected in series.

Both Single Mode and Multimode versions of the Fibre Modem are available.

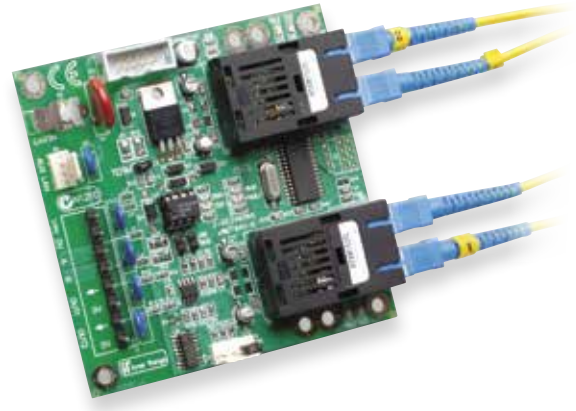

Features

- Multimode Fibre Modems extend Controller LAN up to 3Km
- Single Mode Fibre Modems extend Controller LAN up to 13Km
- Electrical isolation from the remote LAN
- Fibre links immune to earth loops and induced noise
- Immune to propagation of electrical pulses due to lightning
- Supports loop and branch ("Y") configurations
- Redundant LAN path when Fibre Modems used in 'loop' configuration
- 'Loop Fault' and 'Branch Fault' auxiliary outputs

Connectivity

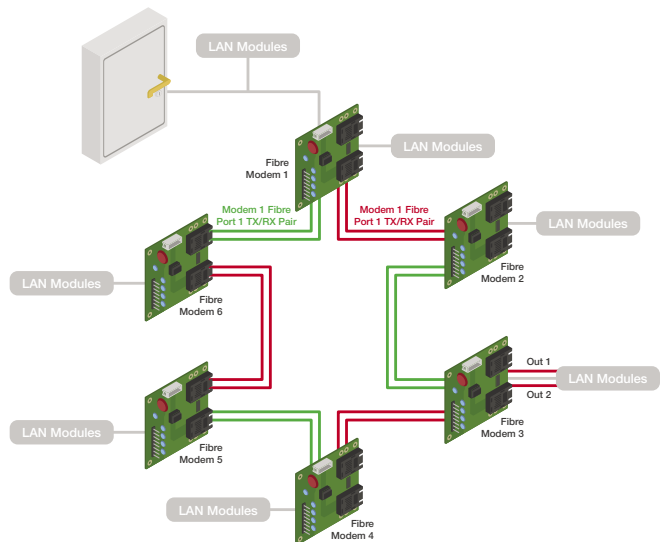

Specifications

Physical

| | |
|---------------------------|---|
| PCB Dimensions: | 96(L) x 96(W) (mm) Note: Fibre Connector heads protrude 15mm from PCB |
| Installation Environment: | 0° – 50°C @ 15% to 85% Relative humidity (non-condensing) |
| Fibre Optic Connections: | Type ST. 62.5/125 820nm multimode cable (Multimode) |
| | Type SC. 9/125 1310nm single mode cable (Single Mode) |

Electrical

| | |
|-----------------------|--|
| Input Voltage to PCB: | 11-14VDC (From LAN or separate battery-backed external power supply) |
| Operational Current: | Min.: 20mA (idle) Max.: 120mA |

Optical

| | |
|---|--------------------------------------|
| Tx Optical Power: | -12dBm (typical) |
| Rx Optical Power: | -24dBm (minimum for logic operation) |
| Max. Modem to Modem Optical Cable Distance (Multimode): | 3km |
| Max. Modem to Modem Optical Cable Distance (Single Mode): | 13km |

Ordering Options



995081
Multimode Fibre Modem



995087
Single Mode Fibre Modem

The LAN Isolator affords an Integriti, Inception or Concept system with optical isolation of RS-485 LAN wiring. It features 2 optically isolated sections (branches) which can be combined to work in an optional LAN 'loop' mode. The elimination of electrical connection between LAN sections serves as a means to break earth loops as well as extending the length of the LAN. Each LAN Isolator amplifies the signal and provides an additional 1500m of LAN distance.

In addition to this, the LAN Isolator monitors its LAN sections and can isolate sections of the LAN where problems are discovered. Also provided are outputs to indicate the status of the LAN allowing LAN section status and alarms to be reported as required.

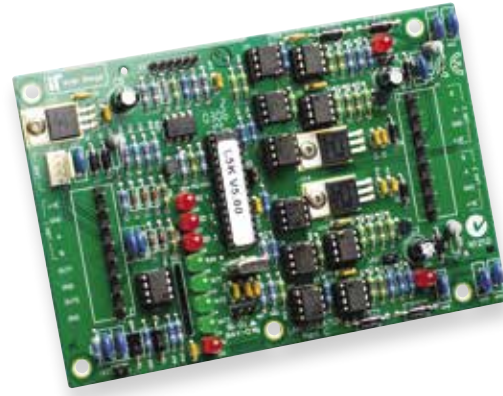

Features

- 5kV isolation between LAN sections
- Can help eliminate earth loops in the LAN
- Improved anti-surge protection
- Improved signal to noise ratio over longer cable runs
- Two downlink ports on each unit allow monitored 'Loop' wiring or two separate downlink 'Branches'
- Supports loop and branch ("Y") configurations
- Protects sections of the LAN from faults or tampering in other sections
- 'Loop Fail' and 'Branch Isolated' alarm outputs can be wired into any standard zone input
- Plastic enclosure supports base and cover tamper switches

Specifications

Physical

| | |
|---------------------------|---|
| Cabinet Dimensions: | 305(L) x 140(W) x 72(D) (mm) |
| PCB Dimensions: | 140(L) x 92(W) (mm) |
| Installation Environment: | 0° – 50°C @ 15% to 85% Relative humidity (non-condensing) |

Electrical

| | |
|--------------------------------|--|
| Input Voltage to PCB: | 11-14VDC (From LAN or separate battery backed external power supply) |
| Operational Current (Standby): | LAN1 section: 28mA, LAN2 or LAN3 section: 15mA |
| Operational Current (Busy): | LAN1 section: 65mA, LAN2 or LAN3 section: 30mA |
| Isolation: | LAN1 - LAN2: 5kV, LAN1 - LAN3: 5kV |
| Alarm Outputs: | 'Loop Fail' and 'Branch Isolated' |

Connectivity

The LAN Isolator is connected directly to the Controller RS-485 LAN. The configuration shown is loop mode, it can also be deployed as 2 separated branches.

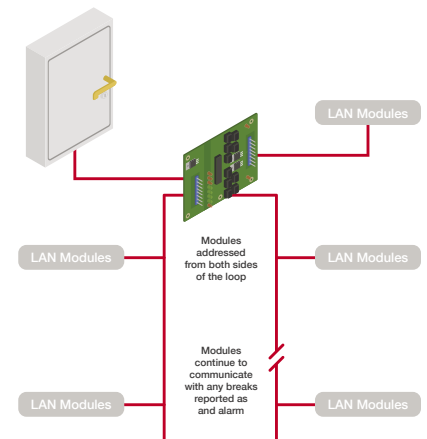

Ordering Options



995080
LAN Isolator in Extra Small enclosure



995080PCB&K
LAN Isolator short form kit



The Integrati Training Kit is purpose-built for those undertaking certified training or customer demonstrations. The kit contains the necessary hardware modules to get hands on experience with wiring and programming access control and intruder detection applications.

Benefits

- A dedicated Training Kit for Certifying your Technicians
- Great for testing and customer demo purposes
- Includes 1 enrolment into the Self-paced Integrati Certified Course
- Easy to fault find
- Easy to assemble
- Affordable
- Great return on investment

Kit Contents:

- 1 x Integrati Security Controller
- 1 x Integrati Standard LAN Access Module
- 2 x SIFER Readers
- 2 x SIFER P ISO Cards
- 1 x EliteX Terminal
- Matte Black Perspex's Test Bench
- Cable Accessory kit
- Custom Input/output board
- Custom Dual Siren Board
- Voucher Code for 1 Online Course Enrolment
- Meanwell AC/DC Plug pack UL Approved
- AU/NZ IEC Power Cord

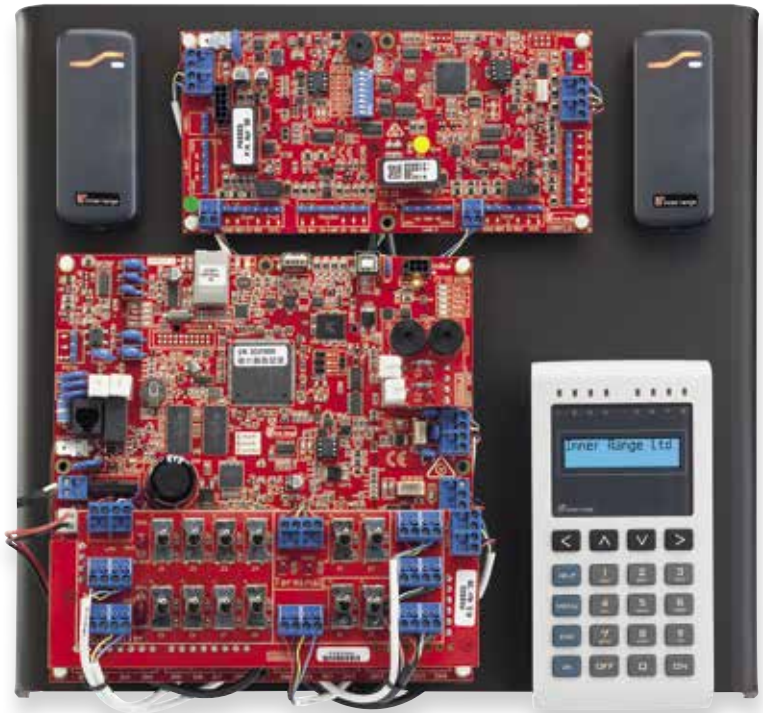

Specifications

Electrical Specifications

Power Supply Source: AC/DC Plug pack

Input: 100-240VAC 50/60Hz 1.4A

Output: 24V 2.5A 60W MAX



Ordering Options

IR-998062 Integrati Training Kit

Multipath-IP



Multipath-IP

Multipath-IP is a state of the art multiple path IP alarm transmission system designed for low-cost monitoring through to high-security applications. Multipath-IP is a suite of products ranging from a variety of field hardware devices installed on the customer's premises to dedicated hardware systems installed within a monitoring station. The Multipath-IP service is available throughout Australia and New Zealand. The service will also be made available in additional regions in future.

Multipath-IP utilises leading edge internet protocol (IP) based technologies, combined with traditional alarm reporting systems to deliver critical alarm events to the monitoring centre via a secure, reliable and lightning-fast system.

High-security monitoring is achieved using a polled communication system where field hardware modules (STUs) communicate with the monitoring control room at intervals as frequent as every 10 secs. If these polls fail to be delivered within the allocated time, Multipath-IP is an agile solution which will attempt to re-establish the connection to the monitoring station using an alternative path and one of several alternative Telco providers. If a failed connection cannot be re-established within a pre-determined time then an alarm is raised within the monitoring station.

Multipath-IP supports most existing alarm systems and is an ideal upgrade from traditional dial-up systems and the perfect replacement for outdated technologies such as direct line or Securitel. Installation of equipment into the customer's premises is a simple process with no ongoing programming required. Multipath-IP is independently certified to Australian Standard AS2201.5 class 5 which is the highest IP monitoring standard available.

SkyTunnel Reporting



T4000 Reporting





SkyCommand

Receive alarm notifications and control your alarm system like never before - anywhere at any time.

SkyCommand delivers alarm notifications and the freedom to control security areas, lights, heating/cooling and door access.

Features:

- Instant notifications for alarm events to your mobile phone*
- Arm and disarm your security system remotely
- Supports multiple sites and security areas
- Remotely turn on and off locks and appliances
- Create favorites lists for quick access to items
- Personalise items with images
- Notification and event history
- PIN or Biometric App entry and lock

*Push Notification is a subscription service. Contact Inner Range for a SkyCommand Dealer form and pricing.



Multipath-IP

Utilising T4000 high-level integration to an Integriti, Inception or Concept system, SkyCommand provides powerful control over door access, security and automation.

Third party alarms systems can also be controlled using the output on a T4000 via a key-switch input on any third party alarm panel.



Easy Access



Multiple Sites & Areas



Simple Control



Notifications

Available now on:



ir inner range
Intelligent Security Solutions

www.innerrange.com

T4000

SECURITY COMMUNICATOR

The Multipath-IP T4000 is a highly advanced and cost-effective field device used to connect any Contact-ID dialer equipped alarm panel to a central monitoring station via multiple highly secure IP paths.

The versatile T4000 is packed with many industry-first features that make it the best tool in any Installer's toolbox. Its core strength focuses on ease of installation, ease of operation and low-cost security monitoring.

Along with all the features you have come to expect such as Dual 4G and Ethernet alarm transmission paths, The T4000 also brings modern capabilities to existing alarm systems such as smartphone apps and push notification service.*

Using its industry first "Router Functionality", the T4000 can even leverage Inner Range's SkyTunnel cloud-based infrastructure for seamless IP connectivity of Inner Range alarm systems.**

The T4000 also provides a communications path for upload/download programming of many popular alarm systems on the market when a PSTN line is not available at the installation site.

The T4000's small footprint allows it to retrofit easily into existing alarm system cabinets or be housed in its own security cabinet with a backup battery.

T4000 Lite

The Multipath-IP T4000 Lite features the same highly advanced feature set as the original T4000. The on-board battery charger and PSTN dial through functions are not fitted to the T4000 Lite, providing the perfect solution for the cost sensitive residential market in areas where the NBN is rolling out. With a smaller price tag, it is a great solution for installations where the T4000 Lite is being powered from an existing battery-backed alarm system.

*Push notification subscription required. **Router data subscription required.

Features

- Simple Plug and Play installation
- Ultra-fast 4G dual SIM polled communications paths
- 10/100 Mbps Ethernet port for high-speed polling
- Configurable bi-directional polling from 10 seconds to 5 minutes to meet the requirements of Australian Standard AS2201.5
- Secure 128Bit AES encrypted data transmission
- Over-the-air upload/download to compatible alarm systems using modem dial-up and serial pass-through methods
- Dialer Capture port to receive communications from any alarm panel equipped with a dialer and programmed to report Contact-ID
- High-level integration with Inner Range Integrity, Inception & Concept Systems
- Remote firmware update capability
- General purpose security input
- Relay output for control of external devices
- Remotely arm/disarm connected alarm system
- App that allows the end user to control their alarm system, i.e. arm/disarm, auxiliary control and automation. Available on Google Play and IOS stores web: <https://skycommand.com.au>
- Alarm reporting using Contact-ID and IRFast with text formats
- Compact and versatile form factor
- Easy to read functional LED status display
- 12-24VDC supply voltage
- Battery backup capability*** (Battery sold separately)

*** Not supported on T4000 Lite.



Package Contents

- T4000 Security Communicator
- 3.5Dbi magnetic antenna - 2m cable
- Dual network SIM cards (Pre-Installed)
- Dialer Capture lead

Connectivity



Specifications

Physical

| | |
|----------------------------|--|
| Size: | 101(L) x 98(W) x 35(D) (mm) |
| Weight: | 190g |
| Mounting: | 4 x M4 screws to chassis |
| Installation Environment: | 0°C - 50°C @15% - 90% relative humidity (non-condensing) |
| Working Temperature Range: | -25°C to +50°C ambient unforced ventilation |

Connections

| | |
|-----------------------|---------------------------------|
| Outputs: | 1 Relay Output |
| Relay Contact Rating: | 2Amp 30VDC |
| Inputs: | 1 configurable (EOL or No-EOL) |
| Ethernet: | 10/100 Mbps |
| PSTN (Phone): | RJ12 (Not fitted on Lite Model) |
| PABX (Panel): | RJ12 Contact-ID Dialer Capture |
| Serial: | RS-232, TTL |

LED Indicators

| | |
|--------------------|----------------------------|
| Status Indicators: | Power/Battery |
| | Panel |
| | GSM Registration |
| | Host (Server Online) |
| | Alarms Buffered |
| | GSM Modem |
| | SIM1/2 |
| | Ethernet Status (Link/Act) |

Alarm Communications

| | |
|----------------|-----------------------------------|
| Alarm Formats: | Contact ID, IRFast, IRFast + Text |
| Encryption: | 128 bit AES |

Upload / Download Data Pass-Through via IP (4G/3G/Ethernet)

| | |
|-------------------|-----------------------------|
| Panel Connection: | Dial-up Modem, Serial RS232 |
| Modem Modulation: | Bell 103, V21, V22 |

PSTN / PABX

| | |
|-------------------------|-----------|
| PSTN Isolation Voltage: | 1500v RMS |
| Max PABX line Voltage: | 65V RMS |
| Max PABX Current: | 30mA |
| PABX Output Level: | -10dBm |
| Max RF Power: | 2 watts |

Power Specifications

| | |
|--------------------------------------|--|
| Input: | 12-24VDC, 200mA nominal (18VDC 1 Amp recommended for Battery backup) |
| Fuse: | PTC protection + on-board fuse (non-replaceable) |
| Charger Supply Current @ 18 volts: | 90mA (Idle) + 30mA (GSM Online) (Not supported on T4000 Lite) |
| Max Output Current: | 500mA average |
| Typical Battery Backup Time: | 72 hours (Not supported on T4000 Lite) |
| Minimum Battery Backup Time: | 48 hours (Not supported on T4000 Lite) |
| Minimum Operating Voltage: | 8 volts |
| Low Battery Sense Voltage (Typical): | 11 volts |

Battery Types

| | |
|----------------------|--|
| Recommended Battery: | 12 Volt SLA (gel) type, 7 Amp-Hour (Not supported on T4000 Lite) |
|----------------------|--|

Compliance

| | |
|----------------|---|
| Electrical: |  |
| Environmental: | RoHS  |

Ordering Options



T4000

Australia

9985304G - Australia Network - Telstra/Optus

New Zealand

998530NZ - T4000 Alarm Communicator Dual Sim-Vodafone NZ/Spark

Accessories



999065

18VDC 1Amp plug pack power supply includes battery cables



995200XS

Extra Small Metal Enclosure



999028

Din Rail Clip Pack (2 Packs)

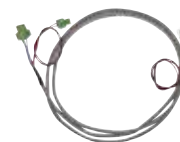

996795

Integriti/Concept Port Zero Interface Cable

996796

Integriti/Concept UART Interface cable

996797

Inception USB Interface cable

For a full range of T4000 accessories see: InnerRange.com/T4000#Accessories

T4000 LITE

4G SECURITY & CONTROL

The Multipath-IP T4000 Lite features the same highly advanced feature set as the original T4000 only in a smaller form factor and packing more inputs and outputs.

The on-board battery charger and PSTN dial through functions are not fitted to the T4000 Lite. With a smaller price tag, it is a great solution for installations where the T4000 Lite is being powered from an existing battery-backed alarm system. Its tiny footprint allows it to easily retrofit into existing alarm system cabinets.

Simply connect any Contact-ID enabled dialler panel into the 'Panel' port for instant cellular alarm reporting.

Along with all the features you have come to expect from T4000, such as Dual 4G and Ethernet alarm transmission paths, The Lite also brings modern capabilities to existing alarm systems such as smartphone apps and push notification service.*

The three outputs built into the Lite are fully controllable from the SkyCommand app by the end user. The outputs can be programmed to control areas on the end user's alarm panel using a keyswitch input or used for general purpose remote control.

Using its industry first "Router Functionality", the T4000 can even leverage Inner Range's SkyTunnel cloud-based infrastructure for seamless IP connectivity of Inner Range alarm systems.**

The T4000 also provides a communications path for upload/download programming of many popular alarm systems on the market when a PSTN line is not available at the installation site.



Features

- Simple plug and play installation
- Ultra-fast 4G dual SIM polled communications paths
- Compatible with most alarm systems
- 3 inputs
- 3 outputs
- Over-the-air upload/download to compatible alarm systems
- Contact-ID and IRFast with text formats
- Remote Control using the SkyCommand smart phone app
- Minimal power consumption
- Over-the-air firmware updatable

Package Contents

- T4000 Lite Security Communicator
- 3.5 dBi Magnetic Base Antenna 2 meter cable
- Accessory Kit
- Installation Manual
- SIM Cards included



998535
T4000 Lite Security Communicator, Dual SIM - Telstra/Optus

998535NZ
T4000 Lite Dual Sim - Vodafone NZ/Spark NZ

998535SPARK
T4000 Lite Single Sim - SPARK NZ

Specifications

Physical

| | |
|---------------------------|--|
| Size: | 101(L) x 79(W) x 23(D) (mm) (Not including connectors) |
| Weight: | 195g |
| Enclosure Type: | ABS plastic |
| Installation Environment: | 0°C - 50°C @ 15% - 90% relative humidity (non-condensing) |

LED Indicators

| | |
|--------------------|---|
| Status Indicators: | 5 |
|--------------------|---|

Alarm Communications

| | |
|----------------|-----------------------------------|
| Alarm Formats: | Contact ID, IRFast, IRFast + Text |
|----------------|-----------------------------------|

PABX

| | |
|------------------------|---------|
| Max PABX line Voltage: | 65V RMS |
| Max PABX Current: | 30mA |
| PABX Output Level: | -10dBm |
| Max RF Power: | 2 watts |

Power Specifications

| | |
|--------------------------------------|---|
| Input: | 12-24VDC, 150mA Nominal |
| Current consumption @ 13V DC: | 115mA (Idle) + 30mA (GSM Online) |
| Minimum operating voltage: | 8V DC |
| Low volts sense voltage (typical): | 11.0V |
| Fuse: | PTC protection + on-board fuse (non-replaceable) |
| Zone input: | 3 Software configurable (EOL or Non-EOL) |
| Open Collector output (OUT) current: | 3 100mA DC per output |

Compliance

| | |
|-------------|---|
| Electrical: |   |
|-------------|---|

| | |
|----------------|-------------|
| Environmental: | RoHS |
|----------------|-------------|

T4000 **ULTRA LITE**

4G SECURITY & CONTROL

The T4000 Ultralite is the lowest cost T4000 model to date making it the ideal communicator for residential security monitoring. Simply connect any Contact-ID enabled dialler panel into the 'Panel' port for instant cellular alarm reporting.

Packing all the power of the original T4000, the Ultralite doesn't sacrifice on capabilities. Its tiny footprint allows it to easily retrofit into existing alarm system cabinets.

The Ultralite connects to the Cat M1 internet of things network which provides superior coverage, in most cases better mobile reception will minimize the installation time and cost without the need for costly high gain antennas.

The T4000 Ultralite is also fully capable of providing an upload/download communications path for older PSTN panels. Upload/download allows remote programming of many popular alarm systems on the market when a PSTN line is not available at the installation site.

The three outputs built into the Ultralite are fully controllable from the SkyCommand app by the end user. The outputs can be programmed to control areas on the end user's alarm panel using a keyswitch input or used for general purpose remote control.



Multipath-IP

Features

- Simple plug and play installation
- Single SIM 4G CatM1
- Compatible with most alarm systems
- 3 inputs
- 3 outputs
- Over-the-air upload/download to compatible alarm systems
- Contact-ID and IRFast with text formats
- Remote Control using the SkyCommand smart phone app
- Minimal power consumption
- Over-the-air firmware updatable

Package Contents

- T4000 Ultralite Security Communicator
- 3.5 dBI Magnetic Base Antenna 2 meter cable
- Accessory Kit
- Installation Manual
- SIM card included



998536
T4000 Ultralite Security Communicator, Single SIM Telstra

998536NZ
T4000 Ultralite Single Sim - Spark NZ - Cat M1 Network Spark (New Zealand)

Specifications

Physical

| | |
|---------------------------|---|
| Size: | 101(L) x 79(W) x 23(D) (mm) (Not including connectors) |
| Weight: | 190g |
| Enclosure Type: | ABS plastic |
| Installation Environment: | 0°C - 50°C @15% - 90% relative humidity (non-condensing) |

LED Indicators

| | |
|--------------------|---|
| Status Indicators: | 5 |
|--------------------|---|

Alarm Communications

| | |
|----------------|-----------------------------------|
| Alarm Formats: | Contact ID, IRFast, IRFast + Text |
|----------------|-----------------------------------|

PABX

| | |
|------------------------|---------|
| Max PABX line Voltage: | 65V RMS |
| Max PABX Current: | 30mA |
| PABX Output Level: | -10dBm |
| Max RF Power: | 2 watts |

Power Specifications

| | |
|--------------------------------------|---|
| Input: | 12-24VDC, 150mA Nominal |
| Current consumption @ 13V DC: | 115mA (Idle) + 30mA (GSM Online) |
| Minimum operating voltage: | 8V DC |
| Low volts sense voltage (typical): | 11.0V |
| Fuse: | PTC protection + on-board fuse (non-replaceable) |
| Zone input: | 3 Software configurable (EOL or Non-EOL) |
| Open Collector output (OUT) current: | 3 100mA DC per output |

Compliance

| | |
|----------------|-------------|
| Electrical: | |
| Environmental: | RoHS |

SkyCommand

Control your security system and receive alarm notifications.
Anywhere. Any time.

- Free iOS & Android apps available
- Keyswitch arm/disarm functionality on popular alarm panels – Paradox/Bosch/Hills/DSC and more
- High level area & output control on Inner Range Panels – Home AUX/Named Action/User controllable
- Push notifications can be offered as a subscription service by a SkyCommand Dealer
- Multiple Site support – Control all of your T4000 connected alarm panels

Introducing the T4000 Ultralite Communicator



- Cost effective solution - \$79 ex. GST per unit
- Telstra CatM1 Network – 12 hour polling only
- Simple plug and play installation
- Works with most dialler capture alarm panels
- OTA firmware updates
- Upload/download capable



Plug and Play



LTE Cat M1



Single SIM



NBN Ready



Upload/Download



SkyCommand App



3 Inputs & Outputs

Power Supplies



Power Supplies

The 8Amp 13.75VDC Smart Power Supply Unit (PSU) is a highly efficient power supply solution designed to meet the modern high spec requirements unique to access control and intruder systems. Monitoring of the power supply status is pivotal to the operation and performance of any security system, and the Integriti 8Amp Smart power supply delivers this very effectively.

When used with the Integriti system, the 8Amp Smart power supply offers Quick-Connect status monitoring of critical power-related aspects such as Battery Fault, Low Battery, Battery Not Present, Battery Failed Test, AC Supply Failure, Supply Low Volts, Power Supply Failure and status monitoring of all Smart Fuses. It also features general purpose AC Fail & Battery Fail alarm outputs and a separate Battery Charger output with Deep Discharge Protection.

The 8Amp Smart power supply features a highly reliable design that offers exceptional stability when used with the recommended battery type and is also suitable for providing power to card readers including Proximity type reader heads.

The Integriti 8Amp Smart power supply is designed primarily for use as a battery-backed supply for Integriti modules supporting the Quick-Connect "External Power" bus connection. This includes the Standard LAN Access Module (SLAM), the Integriti Intelligent LAN Access Module (ILAM), the Integriti 8 Zone LAN Expander and the Integriti Access Controller (IAC).

When used with these modules, the power supply and battery status may be monitored and reported via dedicated System Inputs on the Host Module, with no need to physically wire inputs for power supply monitoring.

The Integriti 8Amp Smart power supply can also be used as a general purpose, battery-backed supply to power legacy or 3rd party equipment via the plug-on screw terminals.



SMART Features

The Integriti 8Amp SMART power supply is designed primarily for use as a battery backed supply for Integriti modules supporting the 10-way Quick-Connect "External Power" bus connection, these modules include:

- The Integriti Standard LAN Access Module (SLAM)
- The Integriti Intelligent LAN Access Module (ILAM)
- The Integriti 8 Zone LAN Expander
- The Integriti Access Controller (IAC)
- High-level monitoring of PSU status (with the above Integriti modules):
 - Battery Fault, Low Battery and Battery Not Present
 - Battery Failed Test - AC Supply Failure
 - Supply Low Volts - Power Supply Failure
 - LAN+ Smart Fuse Tripped - Detector+ Smart Fuse Tripped
- Dynamic battery testing
- Deep Discharge Battery protection
- Battery reverse polarity protection
- Quick-Connect PSU interface for Integriti modules
- Fully overload protected
- Smart Fuse protection
- Intelligent load sharing
- LED status indicators
- Universal low-level status outputs - AC Fail & Battery Fail
- Separate battery charger output
- Constant current limiting on battery charger output
- 3 x heavy duty DC output connections
- 240VAC IEC mains cable input

Connectivity

8Amp 13.75VDC SMART Power Supply



Start Battery Test Input

240VAC 50HZ Input

AC Mains Fail Output

Battery Charger

Battery Fail Output

10-Way Quick-Connect

3 13.75VDC Output Terminals

Specifications

Physical

| | |
|----------------------------|--|
| Size: | 274(L) x 100(W) x 64(D) (mm) |
| Weight: | 1.1 kg (PSU Only) |
| Mounting: | 4 x M4 screws to chassis |
| Installation Environment: | 0°C - 50°C @15% - 90% relative humidity (non-condensing) |
| Working Temperature Range: | -25°C to +50°C ambient unforced ventilation |

High-Level PSU Status Monitoring

(Available when connected to Integriti LAN modules via 10-way Quick-Connect cable)

| | |
|----------------|---|
| Status Alarms: | AC Failure, Power Supply Low Volts, Battery Fault, Battery Low, Battery Not Present, Power Supply Failure, LAN+ Smart Fuse Tripped, Detector+ Smart Fuse Tripped, Battery Failed Test, Trigger Battery Test |
|----------------|---|

Battery Alarm Thresholds

| | |
|-------------------------------|---------|
| Low Battery Alarm: | 11.0VDC |
| Deep Discharge Protection: | 10.4VDC |
| Recovery From Deep Discharge: | 12.2VDC |

Connections

| | |
|----------|--|
| Outputs: | 10-way Quick-Connect socket for Integriti modules 3 x common 13.75VDC +/- Smart Fused heavy duty outputs, suits up to 14 gauge cable Battery charger connection (for 12V lead acid battery) Low-level AC Failure output (open collector output) Low-level Battery Fail output (open collector output) External Earth terminal for connection to enclosure |
| Inputs: | Start Battery Test Input Trigger (zero volt dry contact input) IEC type mains power input socket |

LED Indicators

| | |
|--------------------|--|
| Status Indicators: | AC OK Battery Charging |
| Fault Indicators: | Battery Fault Fault on V+ Connection Fault on Quick-Connect PSU Connection |

Power Specifications

| | |
|---------------------|--|
| Input: | 240VAC, 50Hz, 1.1Amp |
| Mains Fuse: | 2.0A (T) |
| Output Voltage: | 13.75VDC |
| Max Output Current: | 6.5Amp constant + 1.5Amp charger 8.0Amp without charger (intelligent load sharing) 10.0Amp short term with battery support |
| Load Regulation: | < 2.5% @ load 0-9 Amp |
| Output Ripple: | < 100mVRMS @ full load |
| Battery Charging: | CC/CV |

Battery Types

| | |
|----------------------|--|
| Recommended Battery: | 1 or 2, 18Ah 12V Sealed Lead Acid Only |
|----------------------|--|

Safety Standards

| | |
|--|--|
| | AS/NZS 3820, Essential Safety Requirements for Electrical Equipment AS/NZS 60950.1:2011 Information Technology Equipment |
| | Safety AS/NZS CISPR 22:2009 Information Technology Equipment Radio Disturbance Characteristic |
| | Limits and methods of measurement. Class A, Class B with snap-on ferrite placed on the mains cable (Würth 742 717 33) |

Compliance

| | |
|----------------|------|
| Electrical: | |
| Environmental: | RoHS |

Ordering Options



996092

Integriti 8Amp 13.75VDC SMART Power Supply Module, PSU only



995204PE8

WideBody Key Lockable Enclosure fitted with 8Amp 13.75VDC SMART Power Supply



995201PE8

Medium Enclosure fitted with 8Amp 13.75VDC SMART Power Supply

995203PE8

Xlarge Enclosure fitted with 8Amp 13.75VDC SMART Power Supply

995220PE8

Rack Mount Enclosure fitted with 8Amp 13.75VDC SMART Power Supply



Power Supply Cables

996792

Integriti PSU patch lead, 430mm 10way to 10way header (Supports SMART PSU status monitoring with Integriti modules and Integriti 3 & 8Amp SMART PSU's)



996794

Integriti PSU patch lead, 500mm 10way to Red&Black flying leads (Does not support SMART PSU status monitoring with Integriti modules)

The 3Amp 13.75VDC SMART power supply is a universal power supply which can be used wherever battery backed 12V supplies are required.

When used with the Inner Range Integriti system, the 3Amp SMART power supply offers Quick-Connect status monitoring of critical power-related events such as Battery Fault, Low Battery, Battery Not Present, Battery Failed Test, AC Supply Failure, Supply Low Volts, Power Supply Failure and status monitoring of self-resetting, processor controlled Smart Fuses. It also features general purpose AC Fail & Battery Fail alarm outputs and a separate Battery Charger output with Deep Discharge Protection.

The 3Amp power supply boasts a highly reliable design that delivers exceptional stability when used with the recommended battery type and is also suitable for providing power to card readers including Proximity type reader heads.

General Purpose Use

The Integriti 3Amp power supply can also be used as a general purpose, battery-backed, 13.75VDC supply to power legacy or 3rd party equipment via the plug-on screw terminals. It is extensively used to power Integriti or Concept modules, detectors, readers and auxiliary devices such as strobes, sounders and locks.

Features

- High-level monitoring of PSU status (with Integriti modules)
- Quick-Connect PSU interface (for Integriti modules)
- Separate battery charger output
- Deep Discharge Battery protection
- Battery reverse polarity protection
- Smart Fuse protection
- Universal low-level status outputs - AC Fail and Battery Fail
- Low-level Trigger Battery Test input
- Separate LAN+ & DET+ DC output connections (screw terminals)
- 16VAC input (a 4Amp transformer is required)

SMART Features

The Integriti 3Amp SMART power supply is designed primarily for use as a battery backed supply for Integriti modules supporting the 10-way Quick-Connect "External Power" bus connection, these modules include:

- The Integriti Standard LAN Access Module (SLAM)
- The Integriti Intelligent LAN Access Module (ILAM)
- The Integriti 8 Zone LAN Expander
- The Integriti Access Controller (IAC)

When used with these modules the 3Amp PSU offers Plug&Play Quick-Connect high-level status monitoring of critical power-related events such as:

- Battery Fault
- Low Battery
- Battery Not Present
- Battery Failed Test
- AC Supply Failure
- Supply Low Volts
- Power Supply Failure
- Status monitoring of self-resetting, processor controlled Smart Fuses



Connectivity

3Amp 13.75VDC SMART Power Supply

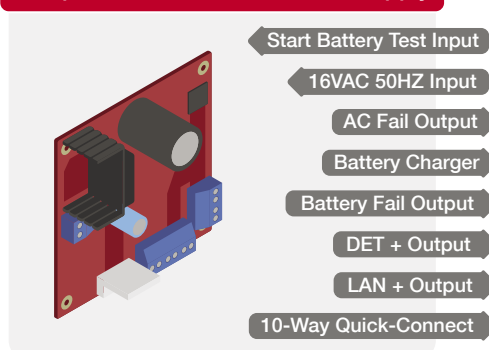

Specifications

Physical

| | |
|----------------------------|--|
| Size: | 95(L) x 95(W) x 45(D) (mm) |
| Mounting: | 4 x M3 screws to Inner Range chassis clips |
| Installation Environment: | 0°C - 50°C @15% - 90% relative humidity (non-condensing) |
| Working Temperature Range: | -25°C to +50°C ambient unforced ventilation |

High-Level PSU Status Monitoring

(Available when connected to Integriti LAN modules via 10-way Quick-Connect cable)

| | |
|----------------|---|
| Status Alarms: | AC Failure, Power Supply Low Volts, Battery Fault, Battery Low, Battery Not Present, Power Supply Failure, LAN+ Smart Fuse Tripped, Detector+ Smart Fuse Tripped, Battery Failed Test, Trigger Battery Test |
|----------------|---|

Battery Alarm Thresholds

| | |
|-------------------------------|---------|
| Low Battery Alarm: | 11.0VDC |
| Deep Discharge Protection: | 10.4VDC |
| Recovery From Deep Discharge: | 12.2VDC |

Connections

| | |
|----------|---|
| Outputs: | 10-way Quick-Connect socket for Integriti modules 1 x DET +/- 13.75VDC & 1 x LAN +/- 13.75VDC Battery charger connection (for 12V lead acid battery) Low-level AC Failure output (open collector output) Low-level Battery Fail output (open collector output) External Earth terminal for connection to enclosure |
| Inputs: | Start Battery Test Input Trigger (zero volt dry contact input) |

LED Indicators

| | |
|--------------------|--|
| Status Indicators: | AC OK Battery Charging |
| Fault Indicators: | Battery Fault Fault on DET+ Connection Fault on LAN + Connection |

Power Specifications

| | |
|------------------------|---|
| Input Voltage: | 16VAC, 50hz |
| Input Current: | 3Amp with 4Amp transformer fitted and LK1 jumper fitted 1.5Amp with 1.5Amp plug-pack fitted and LK1 jumper removed |
| Output Voltage: | 13.75VDC +/-5%, up to 3Amp. (battery fully charged) |
| Max Output Current: | 3Amp with LK1 fitted 1Amp with LK1 removed |
| Switching Frequency: | 370 kHz. approx. |
| Load Regulation: | +0 / -500mV @ I out = 0.1A to 3.0A |
| Conversion Efficiency: | 85%. approx |
| Output Ripple: | < 100mVRMS @ full load |

Battery Types

| | |
|----------------------|--|
| Recommended Battery: | 1 x 7Ah, 9Ah or 18Ah 12V Sealed Lead Acid Only |
|----------------------|--|

Compliance

| | |
|----------------|--|
| Electrical: | |
| Environmental: | |

Ordering Options



996091PCB&K
Integriti 3Amp 13.75VDC SMART Power Supply PCB & accessories



995200PE3
Integriti Small Enclosure fitted with 3Amp 13.75VDC SMART Power Supply and 4Amp mains transformer



995201PE3
Integriti Medium Enclosure fitted with 3Amp 13.75VDC SMART Power Supply and 4Amp mains transformer



995203PE3
Integriti Xlarge Enclosure fitted with 3Amp 13.75VDC SMART Power Supply and 4Amp mains transformer

995204PE3
WideBody Enclosure fitted with 3Amp 13.75VDC SMART Power Supply and 4Amp mains transformer

995220PE3
Rack Drawer fitted with 3Amp 13.75VDC SMART Power Supply and 4Amp mains transformer

Power Supply Cables



996792
Integriti PSU patch lead, 430mm 10way to 10way header (Supports SMART PSU status monitoring with Integriti modules and Integriti 3 & 8Amp SMART PSU's)



996794
Integriti PSU patch lead, 500mm 10way to Red&Black flying leads (Does not support SMART PSU status monitoring with Integriti modules)

The Standard 2Amp 13.75VDC power supply is a universal power supply which can be used wherever battery backed 12V supplies are required. The Standard 2Amp power supply boasts a highly reliable design that offers exceptional stability when used with the recommended battery type and is also suitable for providing power to card readers including Proximity type reader heads. The Standard 2Amp power supply is factory fitted in Small Integriti and Concept equipment enclosures, or supplied as a PCB module.

General Purpose Use

The Standard 2Amp power supply can also be used as a general purpose, battery-backed, 13.75VDC supply to power legacy or 3rd party equipment via the plug-on screw terminals. It is extensively used to power Integriti or Concept modules, detectors, readers and auxiliary devices such as strobes, sounders and locks.

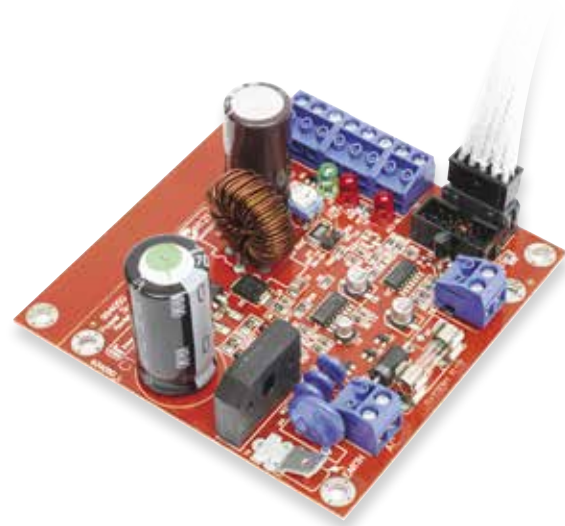

Features

- 10-way Quick-Connect output for Integriti modules such as the Standard LAN Access Module (SLAM), Intelligent LAN Access Module (ILAM) and 8 Zone LAN Expander
- Ribbon cable output for Concept Modules, such as the Mini Expander, and the 2 Door Access module
- Separate DC output connections (screw terminals)
- Low-level AC Fail alarm output with built-in 2K2/2K2 EOL resistors
- Low-level Battery Fail alarm output with built-in 2K2/2K2 EOL resistors
- Low-level Trigger Battery Test input
- Small form factor
- Fused battery protection (4Amp)
- LED indication of Output Present, AC Fail and Low Battery
- Can be linked with a second 2Amp power supply to provide a 4Amp or dual-redundant power source
- Can be set to a 1Amp current limit
- 16VAC input (a 3Amp transformer is required)

Connectivity

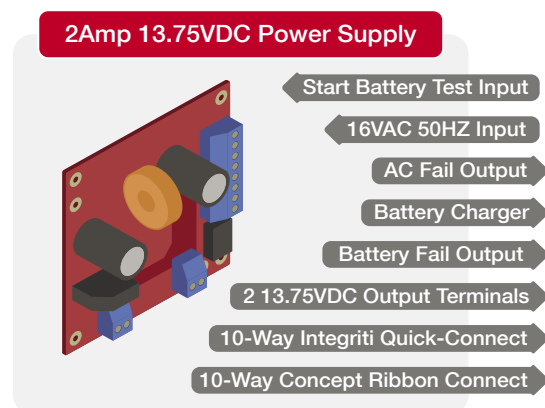

Specifications

Physical

| | |
|----------------------------|--|
| Size: | 95(L) x 95(W) x 45(D) (mm) |
| Mounting: | 4 x M3 screws to Inner Range chassis clips |
| Installation Environment: | 0°C - 50°C @15% - 90% relative humidity (non-condensing) |
| Working Temperature Range: | -25°C to +50°C ambient unforced ventilation |

Battery Alarm Thresholds

| | |
|-------------------------------|---------|
| Low Battery Alarm: | 11.0VDC |
| Deep Discharge Protection: | 10.4VDC |
| Recovery From Deep Discharge: | 12.2VDC |

Connections

| | |
|----------|---|
| Outputs: | 10-way Quick-Connect socket for Integriti modules |
| | 10-way ribbon cable socket for Concept modules |
| | 2 x common 13.75VDC +/- outputs |
| | Battery charger connection (for 12V lead acid battery) |
| | Low-level AC Failure output (open collector output with built-in 2K2/2K2 EOL resistors) |
| | Low-level Battery Fail output (open collector output with built-in 2K2/2K2 EOL resistors) |
| | Low-level Battery Fail output (open collector output) |
| | External Earth terminal for connection to enclosure |
| Inputs: | Start Battery Test Input Trigger (zero volt dry contact input) |

LED Indicators

| | |
|--------------------|------------------------|
| Status Indicators: | Output ON |
| Fault Indicators: | Battery Low AC Fail |

Power Specifications

| | |
|------------------------|--|
| Input Voltage: | 16VAC, 50hz |
| Input Current: | 2Amp with 3Amp transformer fitted and LK1 jumper fitted |
| | 1.5Amp with 1.5Amp plug-pack fitted and LK1 jumper removed |
| Output Voltage: | 13.75VDC +/-5%, up to 2Amp. (battery fully charged) |
| Max Output Current: | 2Amp with LK1 fitted |
| | 1Amp with LK1 removed |
| Switching Frequency: | 370 kHz. approx. |
| Load Regulation: | +0 / -500mV @ Iout = 0.1A to 2.0A |
| Conversion Efficiency: | 85%. approx. |
| Output Ripple: | 100mV RMS max. @ Iout = 2A |

Battery Types

| | |
|----------------------|--|
| Recommended Battery: | 1 x 7Ah, 9Ah or 18Ah 12V Sealed Lead Acid Only |
|----------------------|--|

Compliance

| | |
|----------------|--|
| Electrical: | |
| Environmental: | |

Ordering Options

996090PCB&K

Integriti Standard 2Amp 13.75VDC Power Supply Module, PSU only



995200PE2

Integriti/Concept Small Enclosure fitted with Standard 2Amp 13.75VDC Power Supply and 3Amp mains transformer



995201PE2

Medium Enclosure with 2Amp PSU

995203PE2

Xlarge Enclosure with 2Amp PSU

995220PE2

Rack Drawer with 2Amp PSU

Power Supply Cables

996792

Integriti PSU patch lead, 430mm 10way to 10way header (Supports SMART PSU status monitoring with Integriti modules and Integriti 3 & 8Amp SMART PSU's)



996794

Integriti PSU patch lead, 500mm 10way to Red&Black flying leads (Does not support SMART PSU status monitoring with Integriti modules)



Fire Door Release Relay - DC Power HUB

The 4-way Fire Door Release Relay / Switched DC Power Hub is a universal 1-in-4-out power distribution and switching hub, specifically designed for distribution and switching of DC power to electronic door locking devices. It offers a single input for connection to a DC power supply and 4 universal fused outputs with each output offering both "Always On" and "Switched" connections. This allows other control systems such as fire alarm panels to disconnect power to locks etc. under certain conditions to provide free access at access controlled Doors. The control sense input can be configured for normally closed/normally open contacts or constant 12V/24VDC outputs from the external control or fire alarm system.

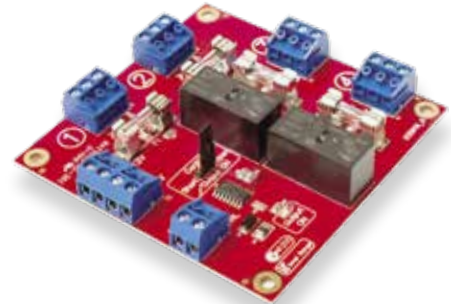

Ordering Options **995916** Fire Door Release Relay / Switched DC Power Hub

Passive Relay Cards

2 x10 Amp Relay Card (Connected Strip of 8)

The 2 x 10Amp x 8 Relay Board provides low voltage, high current relay outputs, offering a general purpose switching interface. The Relay Card is supplied as a strip of 8 boards with a common DC supply connection that can be used complete with all 16 relays or broken down to the required size. The relays can be switched by any open collector auxiliary output capable of switching up to 50mA.

1Amp DPDT Relay Card

The 1 Amp Double-Pole, Double-Throw Relay Card provides low voltage relay outputs offering a general purpose switched interface. A single relay is provided with connections for two independent sets of contacts. The relays can be switched by any open collector auxiliary output capable of switching a minimum of 20mA.

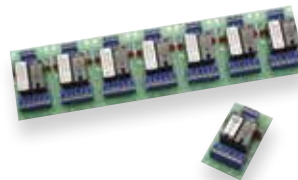

995083M



995085

Ordering Options

995083M 2 x10Amp x 8 Relay Card

995085 1Amp DPDT Relay Card

LAN Hubs & Power +/- Hub

Four types of passive LAN HUBs are available for the distribution of Integrati or Concept RS-485 networks and detector +/- power. The 995911 provides a single 10 way HUB or can be broken into 3 to provide 2 x 3 way sections and 1 x 4 way. The 995915 provides a single compact 8 way HUB. The 995910 provides a single 9 way HUB with additional terminals for detector positive and zero volt connections. The 995914 provides a single 32 way HUB for detector positive and zero volt connections. All HUBs include an LED power indicator and are supplied complete with terminal blocks and mounting posts/self-adhesive mounts.

995911 LAN Hub board (Breakaway Version)

995915 Mini LAN Hub board 8 Way

995910 LAN Hub board 9 Way (With DET+ & 0V)

995914 DET Power LAN Hub board (32 Way DET+ & 0V)

Ordering Options

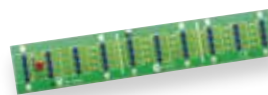

995911

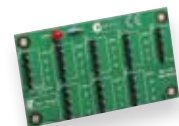

995915

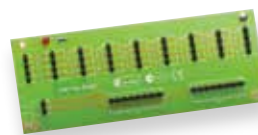

995910

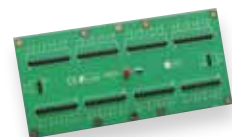

995914

Surge Diverters

Where Integrati or Concept hardware is installed in locations and environments where a very high level of transient electrical activity might be anticipated, the addition of Inner Range Advanced Surge Protection Devices adds a further layer of transient protection.

There are three unique Inner Range Advanced Surge Protection Devices with each device purpose built to provide additional protection in line with the most vulnerable components of the system circuitry: The phone line, the power supply and the Controller RS-485 LAN.



995040 Low Voltage AC and Battery Surge Diverter

995041 Inner Range RS-485 LAN Surge Diverter

995042 PSTN (Telecom) Line Surge Diverter

Ordering Options

Enclosures



Enclosures

The Extra Small Enclosure (XS) is fabricated in the same robust style as the Small, Medium & Extra Large Low Profile Enclosures. The Extra Small Enclosure uses the same mounting plate as the current 995200 series of Small Enclosure and is designed to house Inner Range LAN modules that are either powered via the LAN or an external plug pack or 3rd party power supply.

The Extra Small Enclosure is a versatile enclosure that will house a range of small size PCB's, and also provides an antenna mounting solution for wireless products such as Multipath-IP STU or FE3000 GSM modules.



Specifications

Physical

| | |
|--------------------|-------------------------------------|
| Enclosure Size | 252(L) x 263(W) x 85(D) |
| Cable Entry Points | |
| Top | 4 x 25mm Round Conduit Punch-outs |
| | 1 x Power Entry/Antenna Mount Point |
| Base | 2 x 25mm Round Conduit Punch-outs |
| | 1 x Power Entry |

Ordering Options

995200XS Extra Small Enclosure (Enclosure Only)

Scan here for more layout examples:



Layout Options

Example 1



Example 2

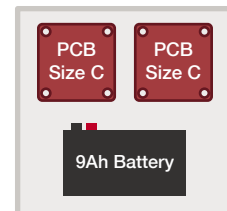

The Small Enclosure (S) is a universal sturdy metal enclosure designed for general purpose installation of small size Inner Range Integrati, Inception or Concept equipment. The design allows for a range of Integrati, Inception or Concept Module PCB's to be fitted. In addition to the Power Supply PCB, 1 x "B" size or 2 x "C" size PCB's may be fitted per enclosure.

A range of powered or non-powered versions are available.

The Small Enclosure's low profile side elevation protrudes less than 90mm from the mounting surface.



Specifications

Physical

| | |
|----------------|-------------------------|
| Enclosure Size | 252(L) x 358(W) x 85(D) |
|----------------|-------------------------|

Cable Entry Points

| | |
|------|--|
| Top | 4 x 25mm Round Conduit Punch-outs |
| | 1 x Power Entry/Antenna Mount Point |
| Base | 2 x 25mm Round Conduit Punch-outs |
| | 1 x Power Entry |
| Back | Through wall cable entry behind main plate |

| | |
|--------------------------|---|
| Powered Versions: 2/3Amp | See the Integrati 2/3 Amp PSU Datasheets for PSU Specifications |
|--------------------------|---|

Ordering Options

- 995200PE2** Small Enclosure Powered with 2Amp PSU
- 995200PE3** Small Enclosure Powered with 3Amp SMART PSU
- 995200** Small Enclosure - (Empty Enclosure)



Scan here for more layout examples:

Layout Options

Example 1

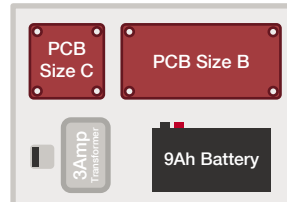

Example 2

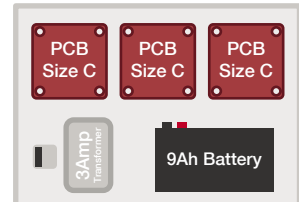

The Integrati Medium Enclosure (M) is a sturdy metal enclosure designed for general purpose installation of Integrati or Inception Controllers, UniBus devices, LAN modules and is backwards compatible with some Concept modules. The flexible design allows for a range of Integrati / Inception equipment to be fitted in various custom configurations to meet many installation requirements.

The Medium Enclosure's low profile side elevation protrudes less than 90mm from the mounting surface.

Features

- Robust metal enclosure
- Designed for universal installation requirements
- Version to suite Integrati & Inception Controllers and Modules
- Mounting options for 18Ah or 9Ah Lead Acid Batteries
- Low Profile design Size 460(L) x 358(W) x 85(D)
- Suitable for Integrati/Inception (or Concept) medium size equipment mounting plates
- Designed to house Integrati PCB's
- Integrati/Inception Controllers
- Integrati LAN Modules
- UniBus Expansion Devices
- Compatible with some Concept PCB's

Specifications

Physical

| | |
|----------------|-------------------------|
| Enclosure Size | 460(L) x 358(W) x 85(D) |
|----------------|-------------------------|

Cable Entry Points

| | |
|----------------------------|--|
| Top | 3 x 25mm Round Conduit Punch-outs 1 x 25x50mm Punch-out 1 x 50x50mm Punch-out 1 x Power entry |
| Base | 2 x 25mm Round Conduit Punch-outs 1 x Power Entry 1 x DB9 Chassis Mount Point |
| Back | Through wall cable entry behind main plate |
| Powered Versions: 2/3/8Amp | See the Integrati 2/3/8Amp PSU Datasheets for PSU Specifications |

Ordering Options

- 995201PE8** Medium Enclosure powered with SMART 8Amp PSU
 - 995201PE3** Medium Enclosure powered with SMART 3Amp PSU
 - 995201PE2** Medium Enclosure powered with 2Amp PSU
 - 995201** Medium Enclosure only - (Empty Enclosure suit Integrati)
- The products listed above are Integrati/Inception versions and are not compatible with some Concept PCB's



Scan here for more layout examples:

Layout Options

Example 1

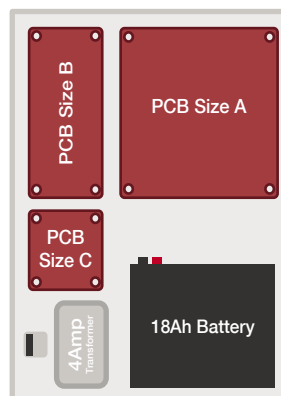

Example 2

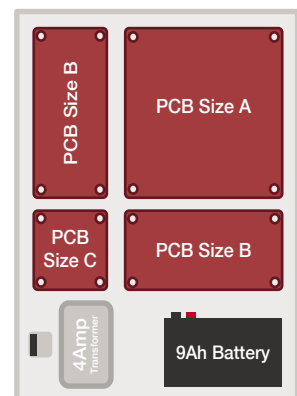

The Extra Large Enclosure (XL) is a universal sturdy metal enclosure designed for general purpose installation of either Inner Range Integrati or Concept equipment. The flexible design allows for the complete range of Integrati or Concept equipment to be fitted in various custom configurations to meet almost any installation requirement.

A range of powered or non-powered models are available.

The Extra Large Enclosure's low profile side elevation protrudes less than 90mm from the mounting surface.

Features

- Robust metal enclosure
- Designed for universal installation requirements
- Suitable for Integrati Controllers and Modules
- Suitable for Concept Controllers and Modules
- Mounting options for 18Ah or 9Ah Lead Acid Batteries
- Optional battery holder brackets are available
- Low profile design - size 702(L) x 358(W) x 85(D)
- Suitable for Integrati or Concept medium or large size equipment mounting plates

Designed for a range of Integrati or Concept Products

- Integrati Controllers (IAC or ISC)
- Integrati LAN Modules
- Integrati UniBus Expansion Devices
- Concept Controllers
- Concept LAN Modules
- Concept Peripheral Devices

Specifications

Physical

| | |
|----------------|-------------------------|
| Enclosure Size | 702(L) x 358(W) x 85(D) |
|----------------|-------------------------|

Cable Entry Points

| | |
|----------------------------|--|
| Top | 2 x 25mm Round Conduit Punch-outs 1 x 25x50mm Punch-out 1 x 50x50mm Punch-out (with 25mm round inset) 1 x Power Entry |
| Base | 1 x 50x50mm Punch-out (with 25mm round inset) 1 x Power Entry 1 x 25x50 IEC lead entry point (Entry plate required) |
| Back | Through wall cable entry behind main plate |
| Powered Versions: 2/3/8Amp | See the Integrati 2/3/8Amp PSU Datasheets for PSU Specifications |

Ordering Options

- 995203PE8** Extra Large Enclosure powered with SMART 8Amp PSU
- 995203PE3** Extra Large Enclosure powered with SMART 3Amp PSU
- 995203PE2** Extra Large Enclosure powered with 2Amp PSU
- 995203** Extra Large Enclosure (Enclosure Only)



Scan here for more layout examples:

Layout Options

Example 1

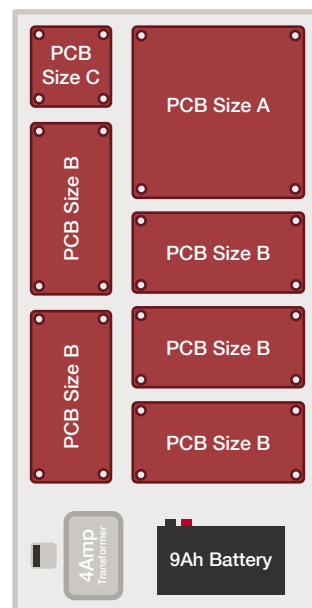

Example 2

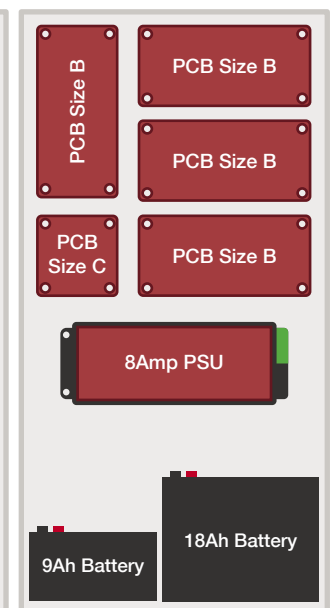

The WideBody Enclosure (WB) is a key lockable sturdy metal enclosure designed for installation of Integriti Access Control solutions where all the Integriti equipment, 3 or 8Amp power supply and backup batteries can be contained within a single tamper monitored enclosure.

The enclosure will house all the equipment required for as many as 8 doors. Multiple enclosures can be installed throughout a building of any size to provide Access Control for the entire facility while keeping the total quantity of installed enclosures to a minimum.

The WideBody design provides very efficient use of wall mounting space, while it's low profile side elevation protrudes less than 100mm from the mounting surface.

Designed to suit a range of Integriti Products

- Integriti Access Controller (IAC)
- Intelligent LAN Access Module (ILAM)
- Integriti LAN Zone Expanders
- 3 or 8Amp SMART Power Supply
- UniBus Expansion Devices
- Concept peripheral Devices

Features

- Key Lockable robust metal enclosure
- Designed for Access Control installations
- Houses all equipment required for up to 8 doors
- Space for 2 x 18Ah Lead Acid Batteries
- Low Profile design Size 595(L) x 512(W) x 95(D)
- 3 x 50x50mm conduit entry points
- 7 x 25mm round conduit entry points
- Discrete thru-wall cable entry via back panel
- Provision for dual front/rear tamper monitoring
- Includes Integriti equipment mounting plate
- Hinged Expansion Plate available (Part 999027)

Specifications

Physical

Enclosure Size 595(L) x 512(W) x 95(D)

Cable Entry Points

| | |
|------|---|
| Top | 4 x 25mm Round Conduit Punch-outs |
| | 2 x 50x50mm Punch-out (with 25mm round inset) |
| Base | 1 x 50x50mm Punch-out (with 25mm round inset) |
| | 1 x Power Entry |
| | 1 x 25x50 IEC lead entry point (Entry plate included) |

Back Through wall cable entry behind main plate

Power Supply

Powered Versions: 3/8Amp - See the Integriti 3/8Amp PSU Datasheets for PSU Specifications

Ordering Options

- 995204PE8** WideBody Enclosure powered with SMART 8Amp PSU
- 995204PE3** WideBody Enclosure powered with SMART 3Amp PSU
- 995204** WideBody Enclosure (Enclosure Only)
- 999027** 2nd tier hinged expansion plate for WideBody Enclosure



Scan here for more layout examples:

Layout Options

Example 1

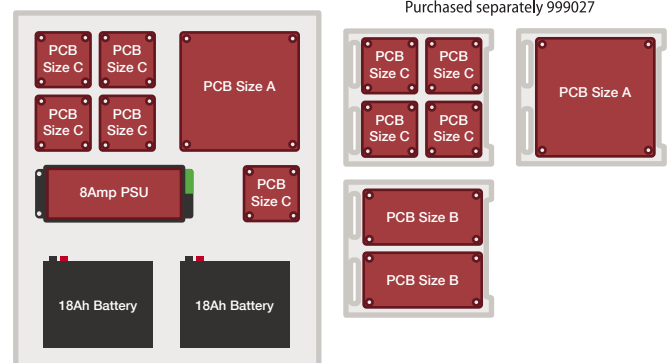

The Inner Range Rack Mount Drawer provides a high-security tamper monitored 2RU rack mounting solution for Integriti system hardware.

It features a truly universal design that allows virtually all Inner Range system Controllers and LAN modules to be installed into a 19" rack equipment cabinet without restricting critical access to cabling, termination of connections or access for commissioning and maintenance purposes.

The Rack Mount Drawer is capable of housing up to two separate internal power supplies with two separate internal 12V, 9Ah sealed lead acid back-up batteries.

Cabling to the drawer is managed via a rear mounted cable tie-down tray with a selection of "knockout" style cable entry points. The mains power connection is via an industry standard IEC connector and the Ethernet network connection is made via a panel mounted RJ45 socket. All other cabling is routed and securely terminated inside the tamper monitored enclosure.

Servicing is made easy as the entire drawer slides out of the rack providing full installation and service access to all components - without taking the system offline.



Scan here for more layout examples:

Features

Drawer Features

- 2RU Sliding 19" Rack Mountable Drawer
- Universal PCB Mounting Plate and Battery Holders
- Sturdy metal drawer with sealed base and welded corners
- Tamper monitored ventilated metal cover
- Rear Cable Tie Down Tray
- Supplied with ball bearing runners to suit front - rear mounting rail spacing of 520 to 740mm - adjustable

Rear Panel Connections and Cable Entry Routing

- 3 x 2-Way Circular Cable Entry Knockouts, 35mm or 64mm - Supplied with cable entry bushing
- Ethernet Connection - RJ45 Chassis Mount
- Mains Power Connection - IEC 240Vac Mains power connector - Fused
- Assisted Ventilation - Provision for 60mm panel mount fan

Layout Options

Example 1

Example 2

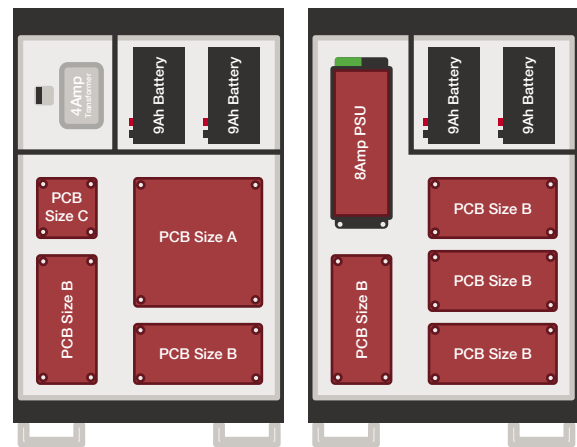

Specifications

Electrical Specification (3Amp Powered Version Only)

| | |
|-------------------------|--|
| Mains Input: | 240V AC, 50Hz |
| Power Supply Input: | 16V AC @ 3A. (From Transformer provided) |
| Output Voltage: | 13.8VDC +/-2% |
| Maximum Output Current: | 3 Amps. |
| Output Ripple: | <100mV RMS max. @ full load. |
| Conversion Efficiency: | 85%. approx. |
| Load Regulation: | +/- 500mV @ Iout = 0.1A to 3.0A. |

See separate PSU datasheets for specifications of 2Amp & 8 Amp models

Mechanical Specifications

| | |
|------------------------|--|
| Dimensions: | 675mm including cable tray and front handles (cable tray 80mm, handles 35mm, drawer 560mm) |
| | Width: 420 mm. Height: 85 mm |
| Rear Cable Tray: | 80mm x 420mm |
| Rack Mount: | Suit 19" Rack with front and back rail mounts |
| Runners: | Adjustable 600mm Ball Bearing runners to suit rail spacing between 520 - 740mm |
| Weight: | 12 kg. (Powered Version) |
| Operating Environment: | 0° to 50° Celsius (Ambient) 15% to 85% Relative humidity (non-condensing) |

Ordering Options

- 995220PE8** Rack Drawer powered with SMART 8Amp PSU
- 995220PE3** Rack Drawer powered with SMART 3Amp PSU
- 995220PE2** Rack Drawer powered with 2Amp PSU
- 995220** Rack Drawer (Drawer Only)

The High Security Enclosure is designed for applications where increased protection against ingress is required such as for Class 5 environments. This enclosure complies with the AS/NZS 2201 Intruder alarm systems standards and exceeds them in many ways. It is built using 1.6mm and 2mm cold-rolled steel, has 7 tamper switch locations, contains a pre-stamped shock sensor location and provides a pre-stamped location which can be used to install a High Gain 4G antenna

To allow for economical customisation the base model is an empty enclosure but with the option to upgrade. Upgrade options include items such as the ASIO evaluated and approved BiLock locking system, additional tamper switches or an addon battery box.

Designed to suit a range of Integrati Products

- Integrati Access Controller (IAC)
- Integrati Security Controller (ISC)
- Intelligent LAN Access Module (ILAM)
- Integrati LAN Zone Expanders
- 8Amp SMART Power Supply
- UniBus Expansion Devices

Features

- Designed for high security installations
- Locations available to install high security locking
- 7 x Locations for tamper switches
- Space for 2 x 18Ah Lead Acid Batteries
- 4 x 32mm round conduit entry points at top
- 2 x 32mm round conduit entry points for Power

Specifications

Physical

Enclosure Size 662(L) x 1150(W) x 157(D)

Cable Entry Points

| | |
|--------|---|
| Top | 4 x 32mm Round Conduit Punch-outs |
| | 1 x 16mm Round Punch-out for 4G antenna |
| Sides | 2 x 32mm Round Punch-outs for power entry |
| Bottom | 1 x 32mm Round Punch-out for cables from optional battery box |

Ordering Options

- 995230** High Security Enclosure (Enclosure Only)
- 995231** Battery Box for High Security Enclosure



* Pictured with optional battery box attached



Scan here for more layout examples:

Layout Options

Example 1

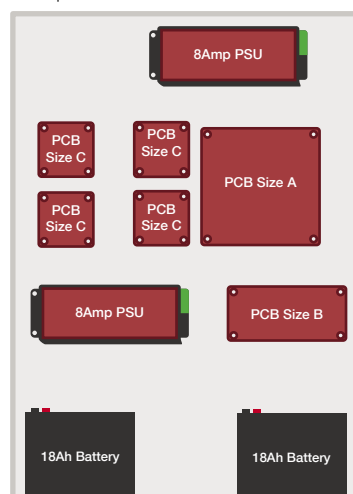

Example 2 - With Optional Battery Box

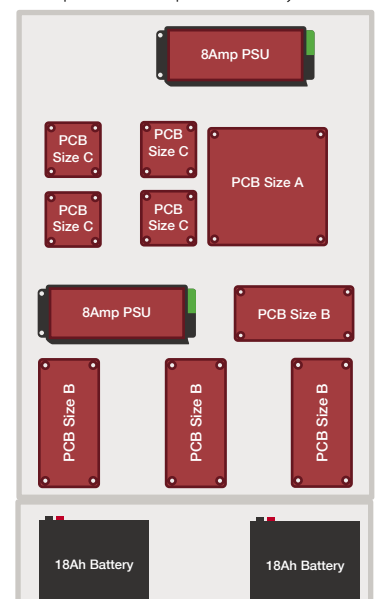

Product Index



Software

| INTEGRITI PROFESSIONAL EDITION | | |
|---|---------|----|
| Professional Edition Features | | |
| Communicator – Email, SMS & Pager Communications | 996901 | 11 |
| Dynamic User Import Module (DUIM) | 996901 | 11 |
| Audit Trail | 996901 | 11 |
| Modern Client/Server Architecture | 996901 | 11 |
| Flexible Workstation / Client Options | 996901 | 11 |
| Smartphone-Server Interface | 996901 | 11 |
| PhotoID Card Design | 996901 | 11 |
| Unlimited Controller Connections | 996901 | 11 |
| INTEGRITI BUSINESS EDITION | | |
| Business Edition Features (Includes all features found in Professional) | | |
| Advanced Reports | 996901B | 12 |
| CCTV Integration – Initial 32 Cameras | 996901B | 12 |
| Licence Plate Recognition Integration | 996901B | 12 |
| Flexible Workstation / Client Options | 996901B | 13 |
| Web Client Connection/Additional Web Client | 996901B | 13 |
| Active Directory Integration – Users | 996901B | 13 |
| Active Directory Integration – Operators | 996901B | 13 |
| INTEGRITI CORPORATE EDITION | | |
| Corporate Edition Features (Includes all features found in Business) | | |
| Advanced Alerts – Alarm Escalation, Response Plans & Operator Challenge | 996901C | 14 |
| User Qualification Manager | 996901C | 14 |
| Guard Tour Manager | 996901C | 14 |
| Flexible Workstation / Client Options | 996901C | 15 |
| Web Server Clients | 996901C | 15 |
| CCTV Integration & License Plate Recognition (LPR) - Unlimited Cameras | 996901C | 15 |
| SNMP & System Health Monitor | 996901C | 15 |

| SOFTWARE EXPANSION OPTIONS | | |
|---|--------|---------|
| Integriti Door License | 996940 | 16 |
| Integriti CCTV Extra 8 Cameras - 996921 (Integriti Business Edition Only) | 996921 | 16 |
| Partitioned Systems | 996915 | 16 |
| Mimic Viewer | 996906 | 16 |
| Inner Range Mobile Reader Application | 996907 | 16 & 21 |
| SOFTWARE INTEGRATIONS | | |
| 3rd Party Door License | 996941 | 17 |
| Mobile Credentials Management Integration | 996964 | 17 |
| Event Review I/O Communications | 996931 | 17 |
| Locker/Key Locker Integration | 996934 | 17 |
| Intercom Integration | 996932 | 17 |
| Modbus Slave Integration | 996968 | 18 |
| Visitor Management Integration | 996935 | 18 |
| Biometric Management Integration | 996969 | 18 |
| Biometric Export Licence for Morpho Manager Software | 996936 | 18 |

| ENTERPRISE INTEGRATIONS & FEATURES | | |
|--|-----------------|----|
| Elevator Management Integration (Lift HLU) | 996933 | 19 |
| Additional Server Node - HA / Load Spreading | 996965 | 19 |
| Milestone Access Control Manager (ACM) Integration | 996939 | 19 |
| Real-Time Location System (RTLS) Integration | 996928 | 19 |
| Active User Rotation Module (AURM) | 996956 | 20 |
| VingCard Integration - VingCard as Master | 996937 | 20 |
| XML API Integration* | 996950 996951 | 20 |
| Inner Range Mobile Reader Application | 996907 | 21 |

| INTEGRITI EXPRESS SOFTWARE EDITION | | |
|---|-----------|----|
| Integriti Express Edition | 996905 | 22 |
| Integriti Express to Professional Upgrade | 996905UPG | 22 |



*Product is available via the Inner Range Technology Partner Program.

Hardware

| INTEGRITI CONTROLLERS | | |
|--|---------------|-------|
| Integrity Security Controller (ISC) in Medium Enclosure with Transformer | 996001AUPS | 31-34 |
| Integrity Security Controller (ISC) PCB Only | 996001AUPCB&K | 31-34 |
| Integrity Access Controller (IAC) PCB Only | 996035PCB&K | 35-38 |
| Level 5 User Expansion Kit for ISC/IAC (one million users) | 996002L5 | 34 |

| INCLUDED FEATURES FOR ISC/IAC CONTROLLERS | | |
|--|--------------------|----|
| Wireless Door Integration (Aperio, SimonsVoss, Salto + others in future) | Controller Feature | 27 |
| Smartphone-Controller Interface for Integrity Mobile App | Controller Feature | 27 |
| Virtual Expansion Modules | Controller Feature | 27 |
| C-Bus Lighting High-Level Interface | Controller Feature | 27 |
| Locker Bank Control | Controller Feature | 27 |

| OPTIONAL FEATURES FOR ISC/IAC CONTROLLERS | | |
|---|---------|----|
| ASCII Automation Interface | 996022 | 28 |
| Modbus BMS Interface | 996228M | 28 |
| Elevator Management System High-Level Interface | 996023 | 28 |
| Honeywell Fire Panel Integration | 996239 | 28 |
| High-Security Fence IP High-Level Interface | 996025 | 29 |
| Advanced Peer-to-Peer Functionality | 996030 | 29 |

| INTEGRITI RS-485 LAN MODULES & UNIBUS DEVICES | | |
|--|-------------|--------|
| Intelligent LAN Access Module (ILAM) / Aperio-SimonsVoss-Salto Interface | 996018PCB&K | 39-40 |
| Standard LAN Access Module (SLAM) / Aperio-SimonsVoss-Salto - Interface | 996012PCB&K | 41-42 |
| 8 Zone LAN Expander | 996005PCB&K | 53-54 |
| UniBus 2 Door / 2 Reader Expander | 996535PCB&K | 55-56 |
| UniBus 8 Zone Expander | 996500PCB&K | 57-58 |
| UniBus 4 Way Analogue Input Expander | 996560PCB&K | 59-60 |
| UniBus 8 Relay Auxiliary Expander | 996515PCB&K | 61-62 |
| UniBus 2 Port RS-232/RS-485 UART | 996520PCB&K | 63-64 |
| UniBus 16 Floor Lift Interface device | 996540PCB&K | 65-66 |
| EliteX OLED Keypad | 995400 | 67 |
| PrismaX Colour Graphic Keypad | 996400 | 68 |
| Security shroud to suit PrismaX/EliteX Keypad | 999059X | 67, 68 |
| Plug-on SIFER Reader kit to suit PrismaX or EliteX Keypads | 994721PCB&K | 67, 68 |
| Weatherproof Keypad | 995010 | 69 |
| Weatherproof Keypad (PCB Only) | 995010PCB&K | 69 |
| Paradox RF Expander Module | 995025 | 70 |
| Inovonics RF Expander Module | 996008 | 71 |
| Aiphone GT Series - Integrity Interface Module | 994210 | 72 |
| Single Door Access Module | 995011PCB&K | 73 |
| Analogue Module Voltage Mode in Extra Small Metal Enclosure | 995088 | 74 |
| Analogue Module Current Mode in Extra Small Metal Enclosure | 995088C | 74 |
| Serial Temperature Sensor | 995089 | 74 |

| LAN MANAGEMENT MODULES | | |
|---------------------------------------|-------------|----|
| LAN Ethernet Bridge Module | 996088 | 75 |
| LAN Over Ethernet Module (CLOE) | 995093 | 76 |
| Multimode Fibre Modem | 995081 | 77 |
| Single Mode Fibre Modem | 995087 | 77 |
| LAN Isolator in Extra Small Enclosure | 995080 | 78 |
| LAN Isolator short form kit | 995080PCB&K | 78 |

| READERS & CARDS | | |
|---|----------|-------|
| SIFER Smart Card Reader | 994720 | 43-44 |
| SIFER Smart Card Reader Multi-Format Version | 994720MF | 44 |
| SIFER Reader Spacer | 999033 | 45 |
| SIFER Reader Vandal Resistant Cover | 999034 | 46 |
| SIFER Reader Vandal Resistant Cover with Inbuilt Spacer | 999035 | 46 |
| SIFER Keypad Smart Card Reader | 994725 | 47-48 |
| SIFER Keypad / Smart Card Reader Multi-Format Version | 994725MF | 47-48 |
| OSDP<->Wiegand Converter Device | 994200 | 50 |

| ISO CARDS | | |
|--|-----------|----|
| Dual Application ISO card SIFER/Aperio | 994614A | 49 |
| Dual Application ISO card SIFER/HID | 994614H | 49 |
| Tri Application ISO card SIFER/Aperio/HID | 994614AH | 49 |
| ECOLITE ISO Card | 994580 47 | 49 |
| SIFER-P ISO Card DESFire® EV2 4K Pre-programed | 994610 | 49 |
| SIFER-U ISO Card DESFire® EV2 4K User-programmable | 994612 | 49 |
| SIFER-C ISO Card DESFire® EV2 4K Custom ordered | 994614 | 49 |
| SIFER-R Reader Configuration Card (For SIFER-C only) | 994614CNF | 49 |

| FOBS | | |
|---|----------|----|
| Dual Application Key Fob SIFER/Aperio | 994620A | 49 |
| Dual Application Key Fob SIFER/HID | 994620H | 49 |
| Tri Application Key Fob SIFER/Aperio/HID | 994620AH | 49 |
| SIFER-P FOB DESFire® EV2 4K Pre-programed | 994616 | 49 |
| SIFER-U FOB DESFire® EV2 4K User-programmable | 994618 | 49 |
| SIFER-C FOB DESFire® EV2 4K Custom ordered | 994620 | 49 |

| SILICON WRIST BANDS | | |
|---------------------|---------|----|
| SIFER-P Wristband | 994625P | 49 |
| SIFER-U Wristband | 994625U | 49 |
| SIFER-C Wristband | 994625C | 49 |

| SELF ADHESIVE COILS/TAGS | | |
|--------------------------|---------|----|
| SIFER-P Tag/Coil | 994621P | 49 |
| SIFER-U Tag/Coil | 994621U | 49 |
| SIFER-C Tag/Coil | 994621C | 49 |

| SIFER MANAGEMENT TOOLS | | |
|--|--------|----|
| SIFER Card Programming Station (Installer tool for SIFER-U Only) | 994750 | 51 |
| SIFER Card Enrolment Station | 994751 | 52 |

Multipath-IP

| AUSTRALIAN NETWORKS | | | NEW ZEALAND NETWORKS | | |
|------------------------------------|----------|-------|---|-------------|-------|
| T4000 Alarm Communicator | 9985304G | 83-84 | T4000 Alarm Communicator Dual Sim- Vodafone NZ/Spark NZ | 998530NZ | 83-84 |
| T4000 Lite Alarm Communicator | 998535 | 85 | T4000 Alarm Communicator Single Sim - Spark NZ | 998530SPARK | |
| T4000 Ultralite Alarm Communicator | 998536 | 86 | T4000 Lite Dual Sim - Vodafone NZ/Spark NZ | 998535NZ | 85 |



Power Supplies

| | | | | | |
|---|-------------|-------|-------------------------|-------------|-------|
| 8Amp SMART Power Supply - The "Cheese Grater" | 996092 | 89-90 | 2Amp Power Supply - PCB | 996090PCB&K | 93-94 |
| 3Amp SMART Power Supply - PCB | 996091PCB&K | 91-92 | | | |



Enclosures

| | | |
|---|-----------|----|
| Extra Small Enclosure (Enclosure Only) | 995200XS | 97 |
| Small Enclosure powered with 2Amp PSU | 995200PE2 | 98 |
| Small Enclosure powered with 3Amp SMART PSU | 995200PE3 | 98 |
| Small Enclosure (Enclosure Only) | 995200 | 98 |

| | | |
|--|-----------|----|
| Medium Enclosure powered with 2Amp PSU | 995201PE2 | 99 |
| Medium Enclosure powered with SMART 3Amp PSU | 995201PE3 | 99 |
| Medium Enclosure powered with SMART 8Amp PSU | 995201PE8 | 99 |
| Medium Enclosure (Enclosure Only) | 995201 | 99 |

| | | |
|---|-----------|-----|
| Extra Large Enclosure powered with SMART 8Amp PSU | 995203PE8 | 100 |
| Extra Large Enclosure powered with SMART 3Amp PSU | 995203PE3 | 100 |
| Extra Large Enclosure powered with 2Amp PSU | 995203PE2 | 100 |
| Extra Large Enclosure (Enclosure Only) | 995203 | 100 |

| | | |
|--|-----------|-----|
| WideBody Enclosure powered with SMART 3Amp PSU | 995204PE3 | 101 |
| WideBody Enclosure powered with SMART 8Amp PSU | 995204PE8 | 101 |
| WideBody Enclosure (Enclosure Only) | 995204 | 101 |
| WideBody Hinged Expansion Plate Option | 999027 | 101 |

| | | |
|---|-----------|-----|
| Rack Drawer powered with 2Amp PSU | 995220PE2 | 102 |
| Rack Drawer powered with SMART 3Amp PSU | 995220PE3 | 102 |
| Rack Drawer powered with SMART 8Amp PSU | 995220PE8 | 102 |
| Rack Drawer (Drawer Only) | 995220 | 102 |

| | | |
|---|--------|-----|
| High Security Enclosure | 995230 | 103 |
| Battery Box for High Security Enclosure | 995231 | 103 |



Parts & Accessories

| INTERFACE CABLES | | |
|--|-----------|----|
| Computer Interface RS232 UART to DB9 | 993009 | 64 |
| Serial Printer Interfaced RS232 UART to DB25 | 993026 | 64 |
| Modem Interface RS232 UART to DB25 | 993027 | 64 |
| Securitel interface cable(Flying leads) | 993035 | 64 |
| Internal PC Interface cable kit | 995009 | 64 |
| Integriti LAN Ancillary Cable | 993028 | - |
| Integriti PORT 0 Interface DB9 | 993030 | - |
| Integriti PORT 0 USB Interface (Includes Device Driver CD) | 993030USB | 50 |

| POWER CABLES | | |
|--|--------|----|
| Integriti Heavy Duty Battery Lead | 999048 | - |
| Eyelet-to-Eyelet cable set for 18Ah parallel batteries | 999067 | - |
| Integriti SMART PSU Patch Cable 430mm 10Way | 996792 | 90 |
| Integriti Ext PSU Bypass Link | 996793 | - |
| Integriti PSU 500mm for 3rd Party Power Supplies 10Way - Red&Black | 996794 | 90 |

| MULTIPATH-IP CABLES | | |
|--|---------|----|
| T4000 Integriti Port Zero Connection Lead | 996795 | 84 |
| T4000 Integriti UART Interface Cable | 996796 | 84 |
| T4000 Inception USB Interface Cable | 996797 | 84 |
| T4000 Paradox Upload/Download Cable | 993041 | - |
| T4000 Challenger V10 Upload/Download Cable | 993042 | - |
| Integriti MPIP OmniLink Interface Port Zero | 996790 | - |
| FE3000 Programming Lead DB9-10WAY IDC | 993039 | - |
| FE3000/GSM Modem Interface 1 Metre Cable Kit | 994092 | - |
| FE3000/GSM Modem Interface 5 Metre Cable Kit | 994092B | - |

| UNIBUS CABLES | | |
|-------------------------------|----------|----|
| UniBus Patch Cable 150mm 6Way | 996791SS | 34 |
| UniBus Patch Cable 220mm 6Way | 996791S | 34 |
| UniBus Patch Cable 270mm 6Way | 996791L | 34 |
| UniBus Patch Cable 475mm 6Way | 996791LL | 34 |
| UniBus Patch Cable 675mm 6Way | 996791XL | 34 |

| TRANSFORMERS & PLUG PACK | | |
|---|----------|----|
| 4 Amp Transformer | 560005 | - |
| 3 Amp Transformer | 560007 | - |
| T4000 18VDC Plug Pack (has 2 way connector fitted) 2 Pack | 999065 | 84 |
| Inception 24VDC Plug Pack | 999066AU | - |
| 240V/16V-1.5Amp 3 Wire Plug Pack | 999004 | - |
| 240V/16V-3Amp 3 Wire Inline Plug Pack | 999012 | - |

| SURGE DIVERTERS | | |
|---|--------|----|
| Low Voltage AC and Battery Surge Diverter | 995040 | 95 |
| RS-485 LAN Surge Diverter | 995041 | 95 |
| PSTN (Telephone Line) Surge Diverter | 995042 | 95 |

| LAN & POWER HUBS | | |
|---|--------|----|
| LAN Hub Board 9-Way RS-485 Hub with DET Plus & Minus power hub | 995910 | 95 |
| LAN Hub Board 10-Way RS-485 or breaks into 3 separate hubs (3, 3 & 4-Way) | 995911 | 95 |
| Detector Power Distribution Hub Board 32-Way | 995914 | 95 |
| Mini LAN Hub Board 8-Way RS-485 Hub | 995915 | 95 |

| PASSIVE RELAY CARDS | | |
|--|---------|----|
| 2 x 10Amp x 8 Passive Relay Card (Break away segments) | 995083M | 95 |
| 1 Amp DPDT Passive Relay Card | 995085 | 95 |
| 4 Way Fire Door Release Relay & DC Power Hub | 995916 | 95 |

| SPARE PARTS & HARDWARE | | |
|--|--------|---|
| IR Fuse Pack | 999000 | - |
| PCB Self Adhesive Standoff Pack 10 x 12mm | 999001 | - |
| PCB Mounting Clip Pack 25 Clips & Screws | 999002 | - |
| 16mm PCB Standoff Kit 10 x 16mm Spacers & Screws | 999003 | - |
| 35mm PCB Standoff Kit 10 x 35mm Spacers & Screws | 999009 | - |
| Grommet Pack | 999014 | - |
| 2K2 Resistor Pack 20 x 2K2 Resistors | 999016 | - |
| 6K8 Resistor Pack 20 x 6K8 Resistors | 999017 | - |
| RS-485 LAN Chip Pack 6 x LAN Chips | 999018 | - |

| CONNECTOR BLOCKS | | |
|--------------------------------------|--------|---|
| 2 Way Terminal Block Pack 8 x 2 Way | 999019 | - |
| 3 Way Terminal Block Pack 8 x 3 Way | 999020 | - |
| 8 Way Terminal Block Pack 4 x 8 Way | 999021 | - |
| 3 Way Fused Terminal Block Kit | 999022 | - |
| Fused IEC Socket Kit for Rack Drawer | 999061 | - |

| ELITE TERMINAL PARTS | | |
|--|----------|---|
| Elite Terminal Large Door (Ivory) | 999049 | - |
| Elite Terminal Large Door (White) | 999049WH | - |
| Elite Terminal Case Full Kit (White) | 910010WH | - |
| Elite Terminal Case Full Kit (Ivory) | 910010 | - |
| Elite Terminal Keypad | 999050 | - |
| Elite Term Tamper Switch Lever Pack of 2 (Ivory) | 999054 | - |
| Elite Term Tamper Switch Lever Pack of 2 (White) | 999055 | - |
| Adhesive for Elite Term Lens Pack of 2 | 999052 | - |

| ENCLOSURE ACCESSORIES | | |
|---|--------|----|
| 19mm Normally Open Tamper Switch Kit For Weather Proof Housing | 999007 | - |
| 19mm Normally Closed Tamper Switch Kit (Open when Pin Pressed) | 999008 | - |
| 15mm TOP Tamper Bracket Suits Low Profile Metal Work Pack of 4 | 999013 | - |
| 19mm TOP Tamper Switch Bracket Suits Low Profile Metal Work Pack of 4 | 999011 | - |
| Small Universal Plate Kit suit XS & S enclosures | 999024 | - |
| Medium Integriti Plate Kit suit M, XL & WB Enclosures | 999026 | 40 |
| Large Universal Plate Kit suit XL enclosure | 999006 | 40 |
| Widebody Hinged Expansion Plate Kit suits WB Enclosure | 999027 | 40 |
| Mounting Plate for Rack Drawer | 999062 | - |
| Extra Plastic Battery Tray for Rack Drawer | 999060 | - |
| Universal Battery Bracket for 7Ah Battery. M & XL Enclosures | 926005 | - |
| Universal Battery Bracket for 17Ah Battery. M & XL Enclosures | 926019 | - |
| DIN Rail Mounting Clips | 999028 | 84 |

integrity Our Integration Partners

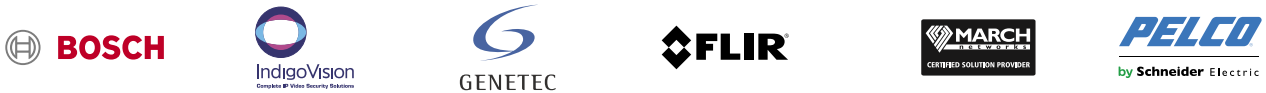

The Inner Range partner portfolio includes many of the world's leading security and building technology products. The Integrity Security Management System can be integrated with these otherwise disparate systems, in order to create a comprehensive and centrally managed integrated security solution.



Healthy Choices 101

The recent \$2B Sunshine Coast University Hospital major government infrastructure project deployed Integriti as the platform of choice. Integriti provides access control for thousands of doors, security monitoring for thousands of alarm inputs and, most importantly, a sophisticated integrated security management system supporting 16 concurrent high-level interfaces (CCTV, Intercom, BMS, Fire, RTLS, KeyLocker, Lifts, Nurse Call and more). This solidifies the installation as one of the most significant electronic security integration projects in the past 10 years. Healthy choices, continuing rewards.

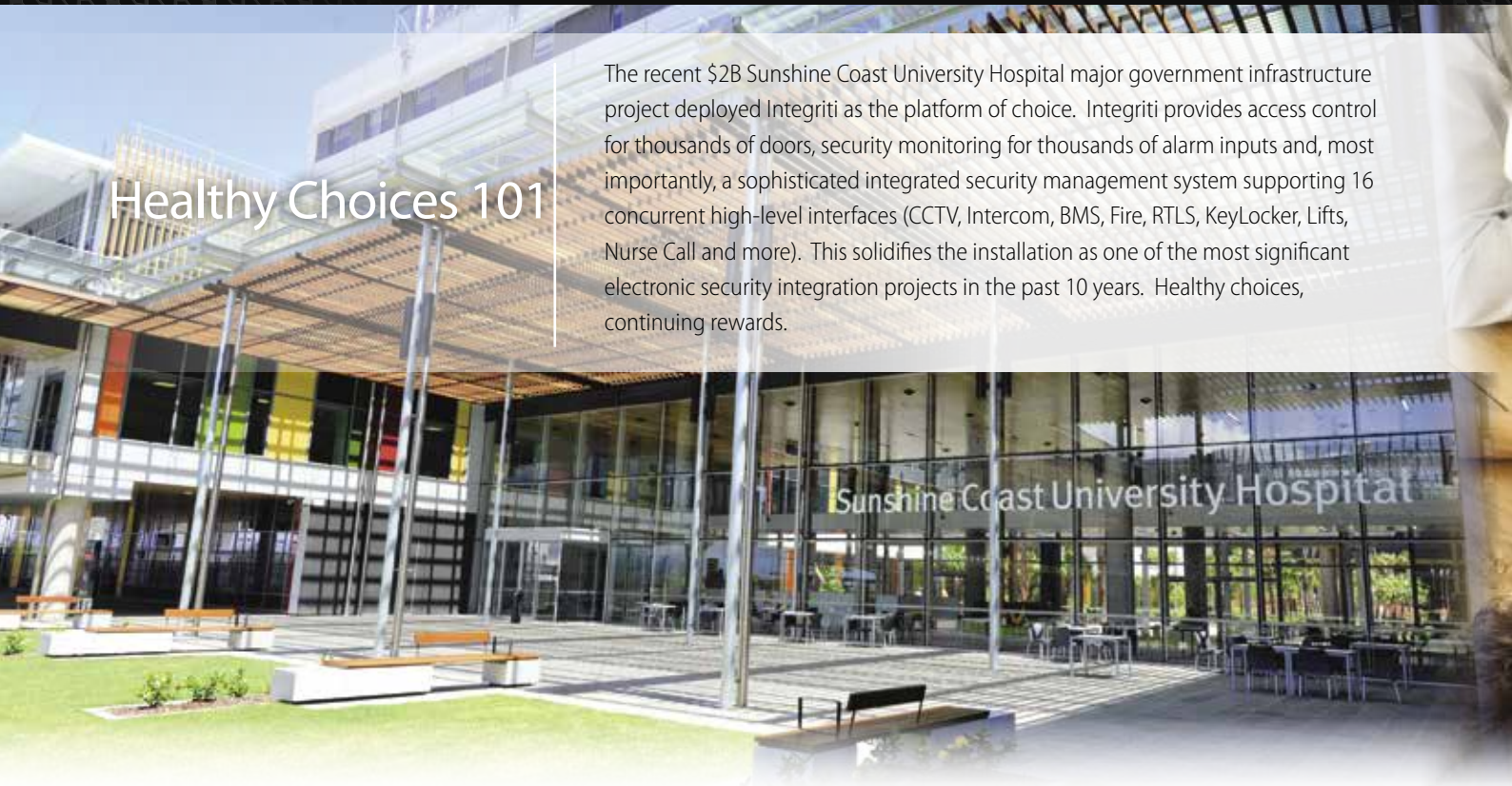

Integriti, whilst feature complete, is at the early stages of its product development life-cycle. Your return on investment is optimised as the typical operational life-expectancy of an Inner Range system is measured in decades.



Integriti boasts powerful, yet intuitive, cardholder permission programming. The use of "Allow" and "Deny" functions greatly simplify system administration. Operator training, and associated costs, are minimal.



Detailed forensic Audit of Operator actions and programming changes, with ability to "roll-back" to any historic point.



Integriti includes a feature-rich suite of tools such as graphical maps, powerful reporting, card printing, alarm management, compliance based access control, email/SMS/pager communications and much, much more.



The Integriti system enables cardholder location and activity information to be shared with Building Management Systems, Air-Conditioning and Lighting systems to reduce the energy costs associated with these services. This represents real cost savings to the business.



The Integriti system can share cardholder data with your company's Active Directory, Employee Database, Payroll System, Student Database or Booking System to reduce the labour costs associated with data entry and cardholder record management.



Integriti supports a wide range of non-proprietary cards, readers, locks, detectors and other peripheral devices. You are not locked into buying the manufacturers specific consumables or peripheral components. A choice of vendors gives you the competitive advantage.



Integriti is a non-proprietary system. You have a wide choice of competent security companies from which to choose. Refer to the Inner Range website for the details of recommended companies.



Inner Range does not impose annual license fees or mandatory Software Maintenance Agreements. Consider the Total Cost of Ownership over the system's lifetime when comparing an Inner Range system to others. You'll be pleasantly surprised.



Mobile Apps for Apple and Android are available for remote monitoring and control.



Inner Range stands behind the quality of its products. Our dealers and customers are fully supported by the Inner Range Professional Services team. A range of free and fee-based services are available, including:

- Software Maintenance Agreements
- Remote Software Support
- System Audits
- Pre-sales Design and Specification Assistance
- Programming and Configuration Support
- Complex Report Writing Service
- System Migration Support
- Custom High Availability Solutions
- Custom Integration Solutions
- Bespoke Development Services

*Please contact Inner Range Professional Services for further details.
professionalservices@innerrange.com
+61 3 9780 4300*

Integrati Deployment Architecture

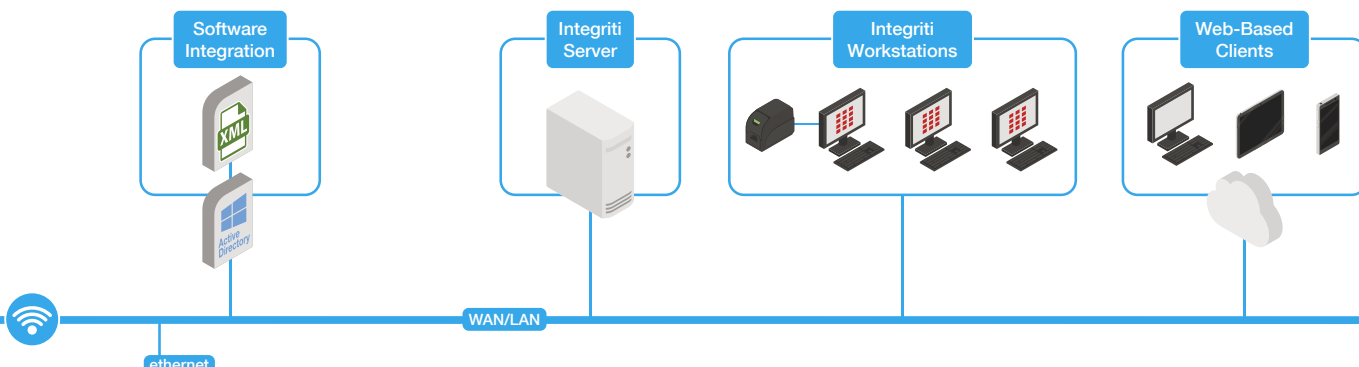

ISC & IAC RS-485 LAN Expansion

Up to 99 Modules of any one type, with a maximum of 250 Modules

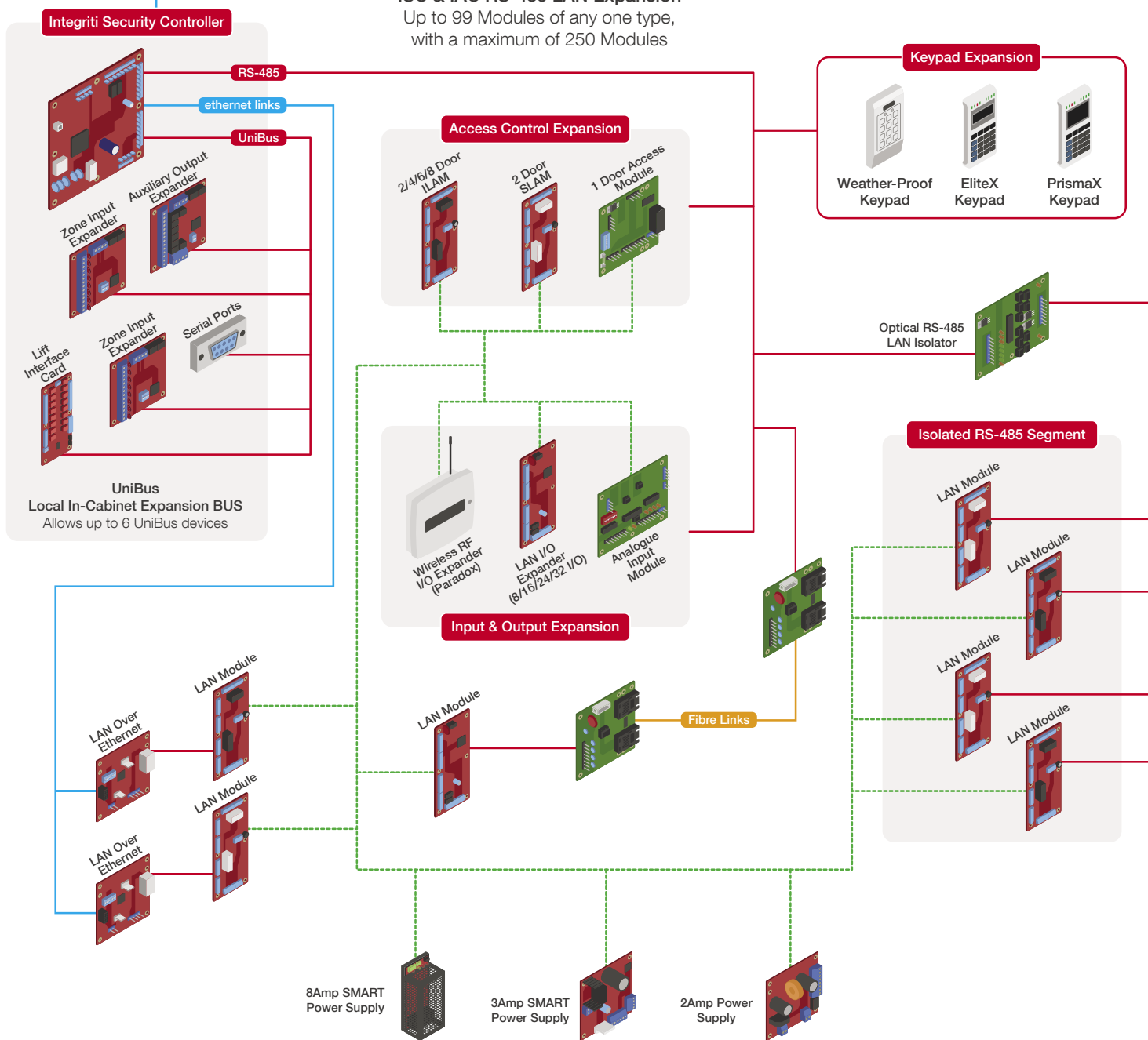

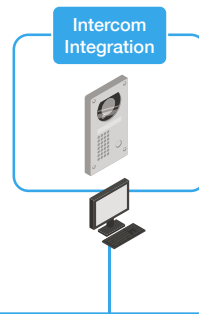
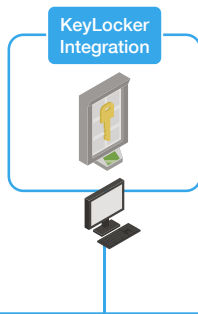
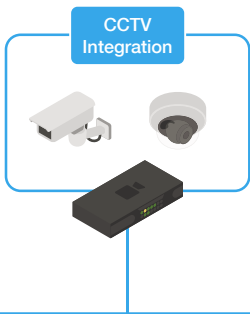

WAN/LAN



ethernet

Integriti Access Controller

Integriti Access Controller
Deployment of local UniBus doors with RS-485 expansion of Standard & Intelligent Access Modules

Standard LAN Access Module

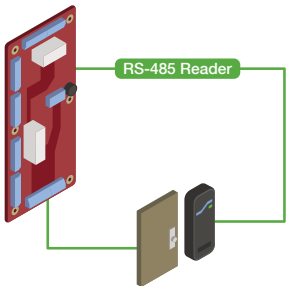

2 Doors & up to 4 SIFER Readers

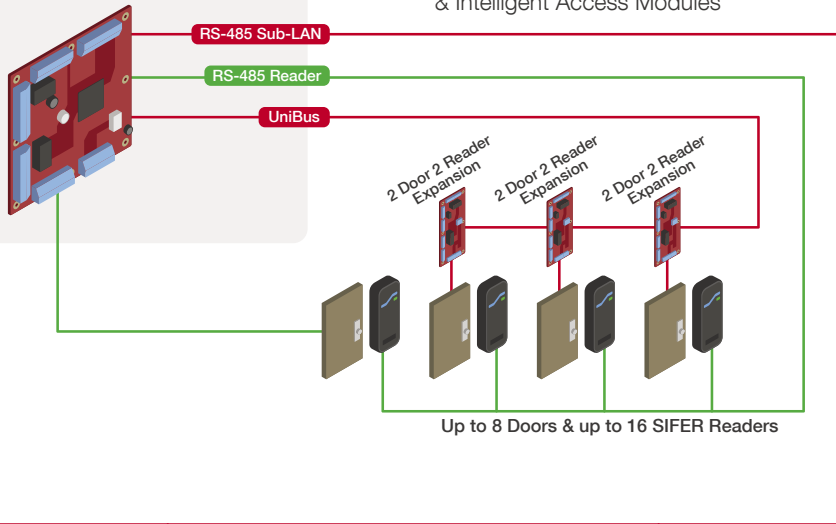

Intelligent LAN Access Module

Standard LAN Access Module

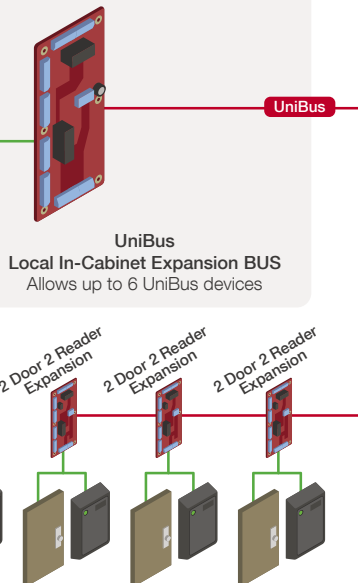
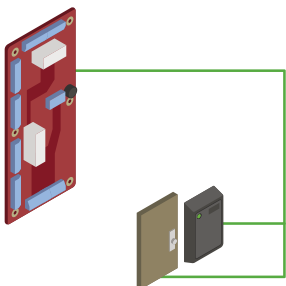

Intelligent LAN Access Module

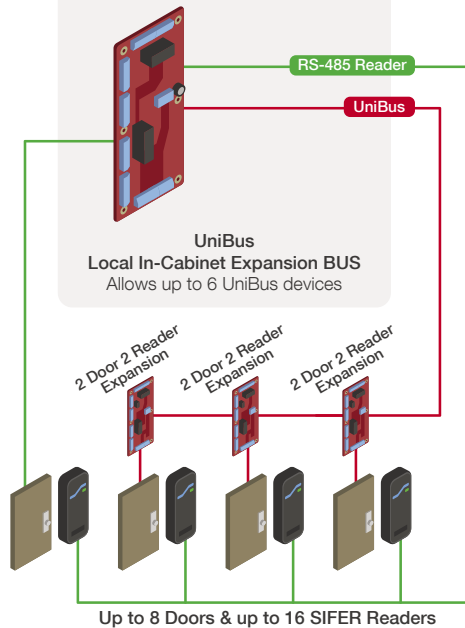

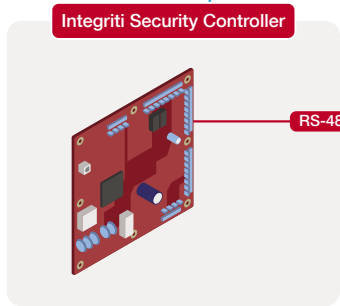
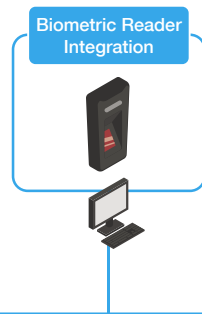
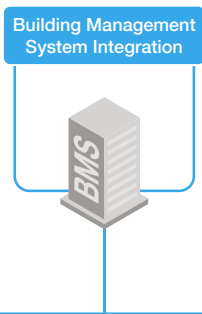
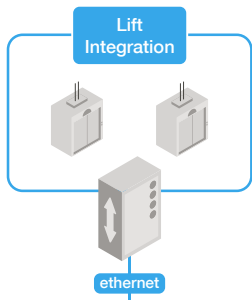

Integriti Security Controller
Deployment of RS-485 Input & Output Modules

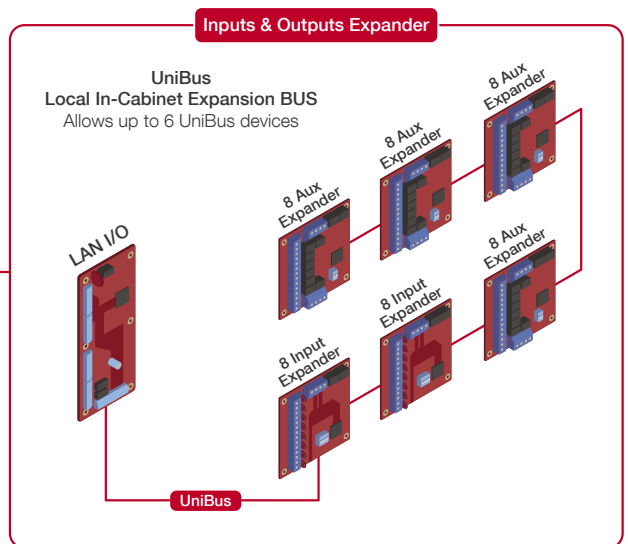
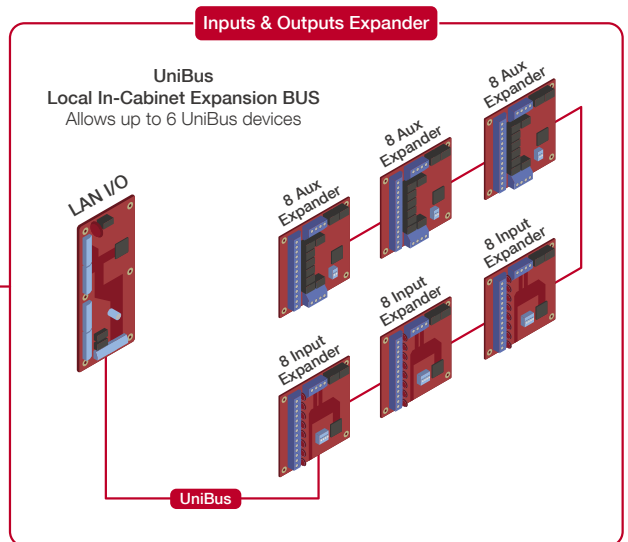
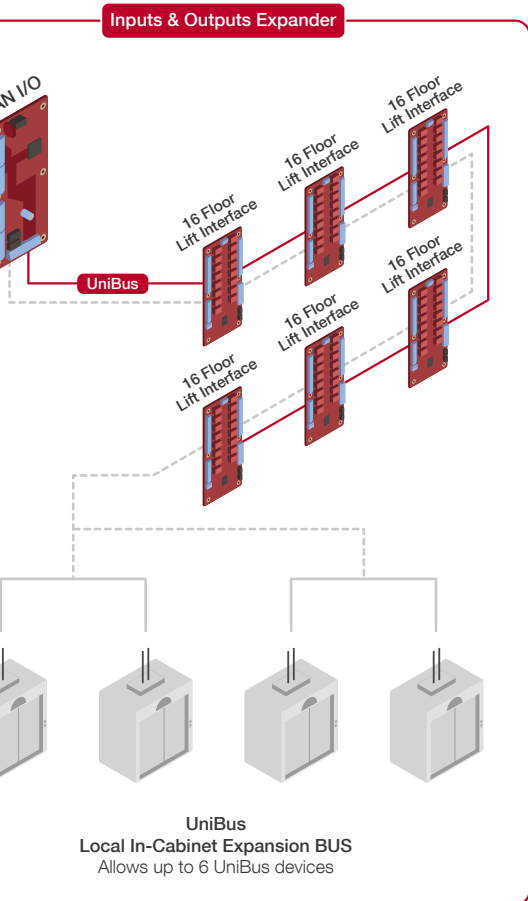

Accredited Dealers

The Inner Range Accredited Dealer Program gives Inner Range customers easy access to a choice of experienced and reputable companies for the installation and service of their intruder alarm and access control system. It is a condition of accreditation that all Accredited Dealers abide by a published Code of Practice. For a company to hold Accredited Dealer status, they must at all times employ at least one Factory Certified Professional.

Inner Range strongly recommends that customers use an Accredited Dealer whose certification level suits their particular application. A list of current Accredited Dealers can be found at: www.innerrange.com/Accredited-Dealers

Factory Certified Training

Inner Range provides three pathways for training and certifications:

1. Interactive Online Classroom Training.

Our structured classroom training is for technicians who have limited exposure to Inner Range products or who want an Inner Range Trainer to guide them through it.

The course is online at specific times and the Final Assessment is taken at the conclusion of the course.

2. Interactive Online Self-Paced Training.

This course is for technicians who already have exposure to Inner Range products however are not certified. It is Self Paced and can be conducted anywhere, anytime. The final assessment can be booked online, and the assessment is included in the course price.

Learning assistance is provided during standard business hours, or using our online discussion boards. Once the participant feels confident in their knowledge they simply need to attend one of the Inner Range assessment days to undertake the official test.

3. Training Assessment Days.

Inner Range certifications are competency based. Individuals who are familiar with the learning outcomes can simply attend an assessment day. Assessment days are conducted throughout the year at our 8 online training centres, conveniently located at Central Security Distribution branches.



Certified Technician

Basic to medium complexity Integrity systems.
E.g. a small business.



Advanced Technician

Medium to high complexity Integrity systems.
E.g. multi-site installations, large businesses, integrated solutions.



All certified technicians are issued with an ID card showing their level of certification and expiry date. Certifications are valid for 3 years and may be renewed for a further 3 years by passing the appropriate assessment. Certification ID cards should be available to be shown if requested.

Australia

Inner Range Pty Ltd
1 Millennium Court Knoxfield, Victoria, 3180, Australia
Tel: +61 3 9780 4300
Fax: +61 3 9753 3499
Email: admin@innerrange.com

innerrange.com





if Timmer van de Product Catalogue 2021

